

# PATIENT LIFTERS & SLINGS

Mobile patient lifters and slings designed for a range of environments, from community to facility



# A150F ALUMINIUM FOLDING LIFTER

The Aidacare Aspire A150F is a lightweight and portable folding patient lifter designed for home and community environments.

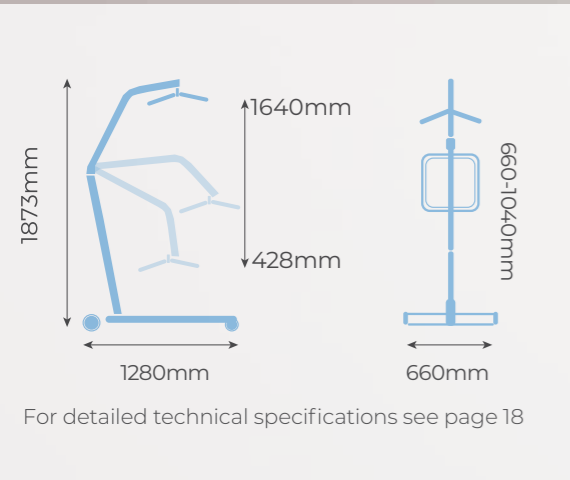

## FEATURES



**FOLDS FOR TRANSPORT AND STORAGE**  
Folds quickly and conveniently for storage or transport in the boot of the car.



**BUILD QUALITY**  
Strong powder coated aluminium frame with industry leading Linak electronics, Tente castors and warranty provision.



**OFFSET LEG DESIGN**  
Provides additional accessibility around chairs and furniture in the home.



**QUICK RELEASE YOKE ATTACHMENT**  
One touch release and attach mechanism, designed for the busy caregiver. Padded yoke for added patient safety



**INTELLIGENT DIAGNOSTICS**  
State of the art Linak Jumbo Care control system. Tracks usage and service requirements for safety and compliance.



**ERGONOMIC HANDSET**  
The latest slimline technology from Linak fits neatly in the hand with an intuitive control panel. Battery and service indicator lights assist with service scheduling



**LEG FUNCTION**  
Simple foot operation to open or close legs for lifting stability or accessibility.



**SAFETY**  
Critical features include emergency stop button, emergency lowering and anti-entrapment technology, with both patient and caregiver safety at heart

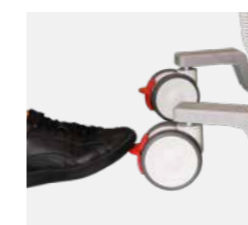

**TENTE**  
2 x 75mm front castors for maximum under bed clearance and accessibility.  
2 x 100mm rear locking castors for safety and manoeuvrability.



**SLING COMPATIBILITY**  
Compatible with a large range of Aspire Slings, as well as other brands  
  
See page 20 for the full range of Aspire Slings



**1 YEAR WARRANTY**  
Battery

**3 YEAR WARRANTY**  
Electronics

**5 YEAR WARRANTY**  
Frame

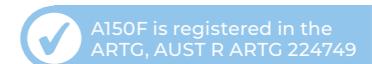

# A205 ALUMINIUM LIFTER

The Aidacare Aspire A205 is a compact and versatile aluminium mobile lifter with powered legs that is ideal for home, community and facility environments.

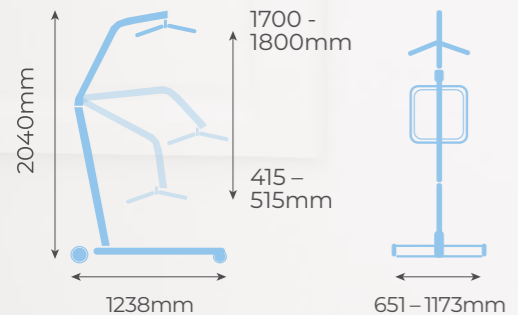

For detailed technical specifications see page 18

## FEATURES

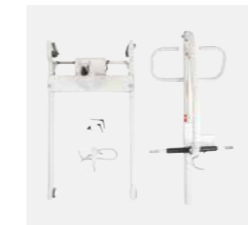

**TRANSPORT OR STORAGE**  
Is quick and convenient with tool free disassembly



**BUILD QUALITY**  
Strong powder coated aluminium frame with industry leading Linak electronics, Tente castors and warranty provision.



**ADJUSTABLE HEIGHT**  
Three adjustable height settings provides the caregiver with the flexibility to adjust the height range to suit the specific lift and patient scenario



**QUICK RELEASE YOKE ATTACHMENT**  
One touch release and attach mechanism, designed for the busy caregiver. Padded yoke for added patient safety.



**INTELLIGENT DIAGNOSTICS**  
State of the art Linak Jumbo Care control system. Tracks usage and service requirements for safety and compliance



**ERGONOMIC HANDSET**  
The latest slimline technology from Linak fits neatly in the hand with an intuitive control panel. Battery and service indicator lights assist with service scheduling



**POWERED LEG FUNCTION**  
Opens and closes the legs for lifting stability or accessibility



**SAFETY**  
Critical features include emergency stop button, emergency lowering and anti-entrapment technology, with both patient and caregiver safety at heart

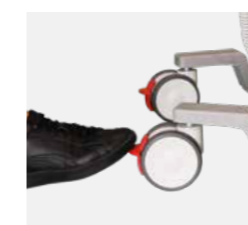

**TENTE**  
2 x 75mm front castors for maximum under bed clearance and accessibility.  
2 x 100mm rear locking castors for safety and manoeuvrability

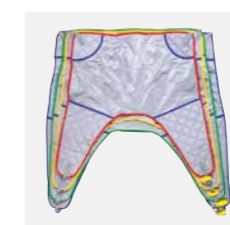

**SLING COMPATIBILITY**  
Compatible with a large range of Aspire Slings, as well as other brands  
  
See page 20 for the full range of Aspire Slings

## DESIGN UPGRADED FOR INCREASED SWL

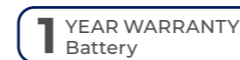

# 200 STEEL LIFTER



A robust workhorse, the Aidacare Aspire 200 is designed to meet the rigorous demands of professional and facility environments.

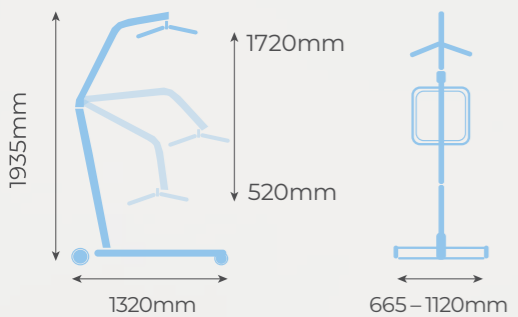

For detailed technical specifications see page 18

## FEATURES



### INTELLIGENT DIAGNOSTICS

State of the art Linak Jumbo Care control system. Tracks usage and service requirements for safety and compliance



### QUICK RELEASE YOKE ATTACHMENT

One touch release and attach mechanism, designed for the busy caregiver. Padded yoke for added patient safety



### ERGONOMIC HANDLES

Provide multiple grip points to suit carers of different heights and strengths



### ERGONOMIC HANDSET

The latest slimline technology from Linak fits neatly in the hand with an intuitive control panel. Battery and service indicator lights assist with service scheduling



### POWERED LEG FUNCTION

Opens and closes the legs for lifting stability or accessibility



### SAFETY

Critical features include emergency stop button, emergency lowering and anti-entrapment technology, with both patient and caregiver safety at heart

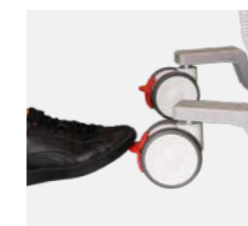

### TENTE

2 x 75mm front castors for maximum under bed clearance and accessibility.

2 x 100mm rear locking castors for safety and manoeuvrability

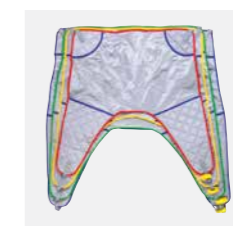

### SLING COMPATIBILITY

Compatible with a large range of Aspire Slings, as well as other brands

See page 20 for the full range of Aspire Slings



### BUILD QUALITY

Strong powder coated aluminium frame with industry leading Linak electronics, Tente castors and warranty provision.



1 YEAR WARRANTY Battery

3 YEAR WARRANTY Electronics

5 YEAR WARRANTY Frame

200 is registered in the ARTG, AUST R ARTG 224749

# A320 ALUMINIUM BARIATRIC LIFTER



The Aidacare Aspire A320 will exceed expectations even in the most demanding clinical environments. Its broad base and ample patient clearance compliments the substantial 320kg safe working load.

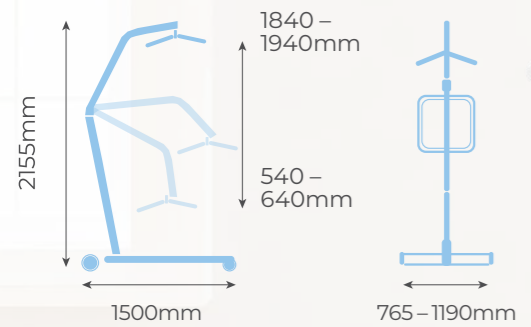

For detailed technical specifications see page 18

## FEATURES



### INTELLIGENT DIAGNOSTICS

State of the art Linak Jumbo Care control system. Tracks usage and service requirements for safety and compliance



### BUILD QUALITY

Strong powder coated aluminium frame with industry leading Linak electronics, Tente castors and warranty provision.



### ADJUSTABLE HEIGHT

Three adjustable height settings provides the caregiver with the flexibility to adjust the height range to suit the specific lift and patient scenario



### QUICK RELEASE 4 POINT YOKE

Padded 4 point yoke for added patient safety. One touch release and attach mechanism, designed for the busy caregiver

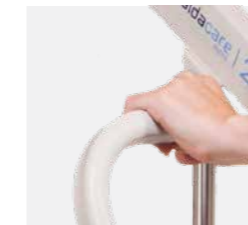

### ERGONOMIC HANDLES AND SUPPORT ARMS

Provide multiple grip points to suit carers of different heights and strengths. Folding support arms assist with stability or mobility but can also be folded out of the way



### ERGONOMIC HANDSET

The latest slimline technology from Linak fits neatly in the hand with an intuitive control panel. Battery and service indicator lights assist with service scheduling

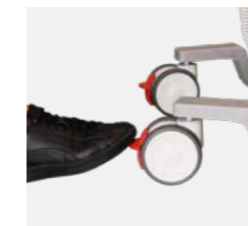

### TENTE

2 x 100mm front castors for reduced rolling resistance under high load.  
2 x 125mm rear locking castors for safety and manoeuvrability



### SAFETY

Critical features include emergency stop button, emergency lowering and anti-entrapment technology, with both patient and caregiver safety at heart



### POWERED LEG FUNCTION

Opens and closes the legs for lifting stability or accessibility

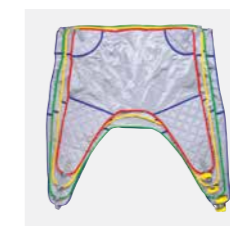

### SLING COMPATIBILITY

Compatible with a large range of Aspire Slings, as well as other brands

See page 20 for the full range of Aspire Slings



1 YEAR WARRANTY Battery

3 YEAR WARRANTY Electronics

5 YEAR WARRANTY Frame

A320 is registered in the ARTG, AUST R ARTG 224749

# A200S ALUMINIUM PATIENT STANDER



The Aidacare Aspire A200S is a compact, lightweight and manoeuvrable standing lifter ideal for home, community and facility environments.

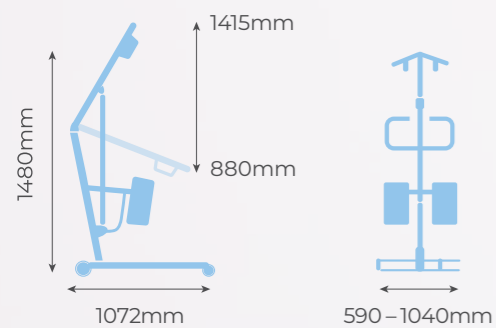

For detailed technical specifications see page 18

## FEATURES



### INTELLIGENT DIAGNOSTICS

State of the art Linak Jumbo Care control system. Tracks usage and service requirements for safety and compliance



### BUILD QUALITY

Strong powder coated aluminium frame with industry leading Linak electronics, Tente castors and warranty provision.



### ADJUSTABLE PADDED LEGRESTS

Provide comfort and support during transfers and can be adjusted to suit the patient



### ADJUSTABLE DEPTH YOKE

Yoke is depth adjustable for optimal patient fit

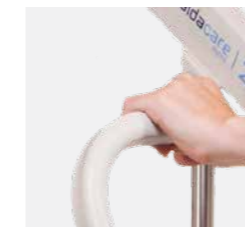

### ERGONOMIC HANDLES

Provide multiple grip points to suit carers of different heights and strengths



### ERGONOMIC HANDSET

The latest slimline technology from Linak fits neatly in the hand with an intuitive control panel. Battery and service indicator lights assist with service scheduling



### TENTE

2 x 75mm front castors for maximum under bed clearance and accessibility.  
2 x 75mm rear locking castors for safety and manoeuvrability



### SAFETY

Critical features include emergency stop button, emergency lowering and anti-entrapment technology, with both patient and caregiver safety at heart



### POWERED LEG FUNCTION

Opens and closes the legs for lifting stability or accessibility

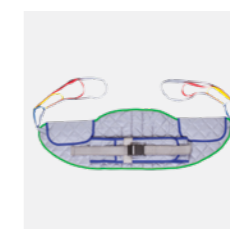

### SLING COMPATIBILITY

Compatible with a large range of Aspire Slings, as well as other brands

See page 20 for the full range of Aspire Slings



**1** YEAR WARRANTY Battery

**3** YEAR WARRANTY Electronics

**5** YEAR WARRANTY Frame

A200S is registered in the ARTG, AUST R ARTG 224749

# 200S STEEL PATIENT STANDER



The Aidacare Aspire 200S is a robust and durable steel standing lifter capable in the most demanding facility environments.

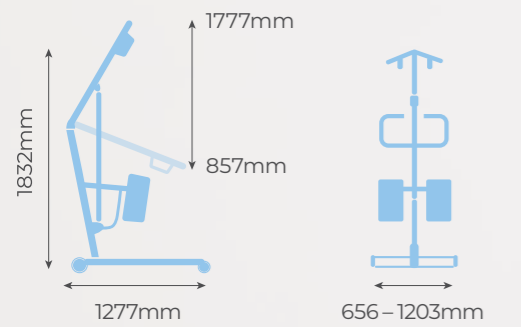

For detailed technical specifications see page 18

## FEATURES



### INTELLIGENT DIAGNOSTICS

State of the art Linak Jumbo Care control system. Tracks usage and service requirements for safety and compliance



### BUILD QUALITY

Strong powder coated aluminium frame with industry leading Linak electronics, Tente castors and warranty provision.

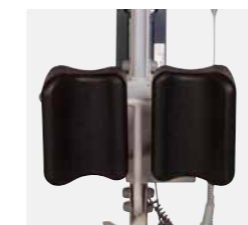

### ADJUSTABLE PADDED LEGRESTS

Provide comfort and support during transfers and can be adjusted to suit the patient



### BULLHORN LIFTING BOOM

Offset patient handles provide stability and 6 sling attachment points give the carer flexibility to perform the optimal lift in any scenario

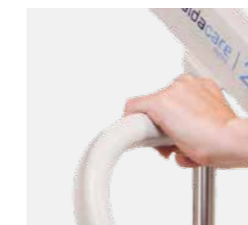

### ERGONOMIC HANDLES

Provide multiple grip points to suit carers of different heights and strengths



### ERGONOMIC HANDSET

The latest slimline technology from Linak fits neatly in the hand with an intuitive control panel. Battery and service indicator lights assist with service scheduling



### TENTE

2 x 75mm front castors for maximum under bed clearance and accessibility.  
2 x 75mm rear locking castors for safety and manoeuvrability



### SAFETY

Critical features include emergency stop button, emergency lowering and anti-entrapment technology, with both patient and caregiver safety at heart



### POWERED LEG FUNCTION

Opens and closes the legs for lifting stability or accessibility

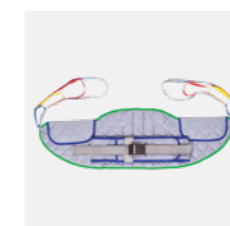

### SLING COMPATIBILITY

Compatible with a large range of Aspire Slings, as well as other brands

See page 20 for the full range of Aspire Slings



### 200S CLIP SLING BAR ATTACHMENT

One-for-one swap of existing sling bar converts stander to accept clip slings only (retro-fit)

Product code: LSS390655



1 YEAR WARRANTY Battery

3 YEAR WARRANTY Electronics

5 YEAR WARRANTY Frame

200S is registered in the ARTG, AUST R ARTG 224749

# STAR PATIENT MOVER



The Aspire Star Patient Mover (the Star Mover), provides a simple solution for transferring a user from a bed or chair in comfort and safety. Offering a compact and versatile design, the Star Mover is suitable for Homecare, Acute Care and Aged Care environments.



<p><b>OVERALL WIDTH</b></p> <p>615 – 900mm</p>	<p><b>KNEE PAD HEIGHT</b></p> <p>205 – 495mm</p>
<p><b>OVERALL LENGTH</b></p> <p>925mm</p>	<p><b>OVERALL HEIGHT</b></p> <p>1030mm</p>
<p><b>SEAT PAD HEIGHT</b></p> <p>685 – 850mm</p>	<p><b>HANDLE HEIGHT</b></p> <p>1030mm</p>
<p><b>LEG RANGE</b></p> <p>Min. External Leg Width: 520mm</p>	<p><b>FOOTPLATE HEIGHT FROM FLOOR</b></p> <p>60mm</p>

## FEATURES



### CLIP SLING ATTACHMENT POINTS

Allows a standing sling (optional accessory) with clips to be used for additional support where required

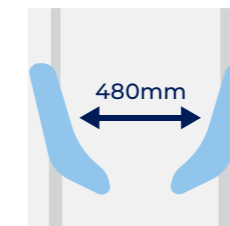

### WIDE SEAT ENTRY SPACE

Wide seat entry suits a larger range of body shapes



### FOUR USER CONTACT POINTS

The foot platform, knee pad, seat pads and grip handle promote stability, support and comfort for the user – resulting in greater confidence in transfers



### SOFT TOUCH GRAB BARS

Two bars to suit multiple user heights provide a comfortable patient support for improved stability and confidence during transfers



### HEIGHT ADJUSTABLE SOFT KNEE PAD

Provides comfortable counter balance stability during transfers

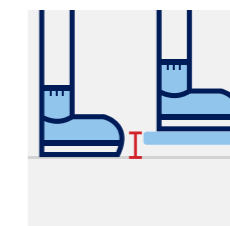

### LOW FOOTPLATE HEIGHT

Low footplate height makes patient entry and exit easier



### LOCKABLE 75MM CASTORS

The platform remains stationary while a user is transferring, while minimising the leg height for sufficient clearance beneath beds and furniture



### LOW FOOTPLATE HEIGHT

Low footplate height makes patient entry and exit easier

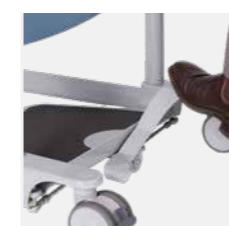

### WIDTH ADJUSTABLE LEGS

Activated via 2 foot pedals, provide the ability to manoeuvre closer to furniture, toilets or beds for safer access

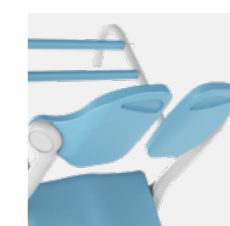

### EASY TO CLEAN SURFACES

For effective and hassle-free infection control

For detailed technical specifications see page 18

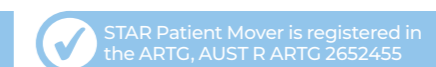



# INLINE WEIGHT SCALE



# MANUAL & POWERED PIVOT FRAMES

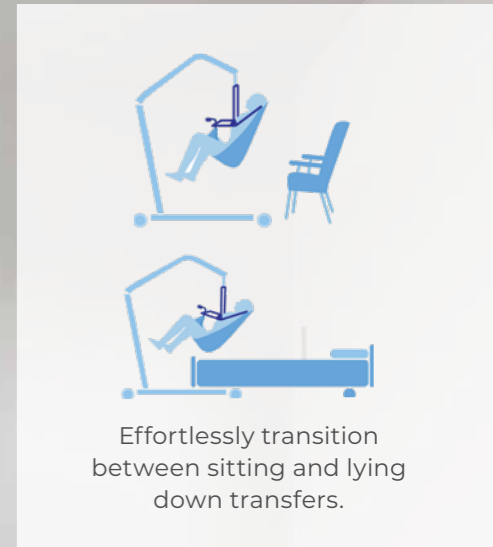

## FEATURES



**ADAPTABLE TO MOST LIFTERS**  
Designed to be fitted on Aidacare Aspire Patient Lifters, however adaptable to most lifter brands.



**ACCURATE WEIGHT**  
Allows for an accurate weight measurement to be taken by a carer when a patient is suspended in a sling.



**WEIGHT CAPACITY**  
Large weight capacity of up to 320kg.



**EASY TO READ**  
Easy to read LCD display.

## FEATURES



**ADAPTABLE TO MOST LIFTERS**  
Designed to be fitted on Aidacare Aspire Patient Lifters, however adaptable to most lifter brands.



**ACCURATE WEIGHT**  
Allows for an accurate weight measurement to be taken by a carer when a patient is suspended in a sling.



**WEIGHT CAPACITY**  
Large weight capacity of up to 320kg.



**EASY TO READ**  
Easy to read LCD display.

### SUITS ASPIRE MODELS

- A150F** Aluminium Folding Lifter See page 2 – 3
- A205** Aluminium Patient Lifter See page 4 – 5
- 200** Steel Patient Lifter See page 6 – 7
- A320** Aluminium Bariatric Lifter See page 8 – 9

### SUITS ASPIRE MODELS

- A205** Aluminium Patient Lifter See page 4 – 5
- 200** Steel Patient Lifter See page 6 – 7
- A320** Aluminium Bariatric Lifter See page 8 – 9

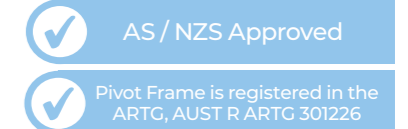
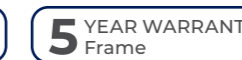
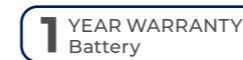
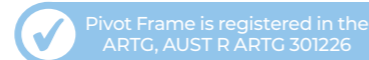

# LIFTER RANGE



**A150F**

**A205**

**200**

**A320**

**A200S**

**200S**

**STAR**

Product Code	LSS390600	LSS390610	LSS390620	LSS390630	LSS390640	LSS390650	LSS390580
Safe Working Load (SWL)	150kg	205kg	200kg	320kg	200kg	200kg	185kg
Base Length	1280mm (1220mm folded)	1238mm	1320mm	1500mm	1070mm	1277mm	925mm
External Base Width	660-1040mm (615mm folded)	651-1173mm	665-1120mm	765-1190mm	590-1040mm	656-1203mm	520mm
Internal Base Width	580-950mm	547-1073mm	580-1040mm	640-1065mm	490-940mm	561-1103mm	740mm
Base Width Adjustment	Manual	Electric	Electric	Electric	Electric	Electric	Manual
Base Height Under Bed Clearance	133mm	110mm	110mm	155mm	110mm	110mm	60mm
Minimum Height of Spreader Bar **	428mm	415-515mm	520mm	540-640mm	880mm	857mm	-
Maximum Height of Spreader Bar**	1640mm	1700-1800mm	1720mm	1840-1940mm	1415mm	1777mm	-
Product Weight	32.9kg	38.1kg	40kg	63kg	33kg	40kg	40kg
Under Base Height	72mm	50mm	50mm	155mm	50mm	50mm	-
Maximum Overall Height	1873mm (395mm folded)	2040mm	1935mm	2155mm	1480mm	1832mm	1030mm
Front Castor Diameter	75mm	75mm	75mm	100mm	75mm	75mm	100mm
Rear Locking Castor Diameter	100mm	100mm	100mm	125mm	75mm	100mm	100mm
Turning Radius	1365mm	1332mm	1398mm	1595mm	1160mm	1361mm	-
Weight Of Heaviest Part (Base Assembly)	32.9kg	19.6kg	23.0kg	38.9kg	19kg	19.6kg	-
Handle Height	1170mm	1085-1185mm	1220mm	1200-1300mm	1160mm	1045mm	1030mm
Warranty – Frame	5 Years	5 Years	5 Years	5 Years	5 Years	5 Years	2 Years
Warranty – Electronics	3 Years	3 Years	3 Years	3 Years	3 Years	3 Years	-
Warranty – Battery*	1 Year	1 Year	1 Year	1 Year	1 Year	1 Year	-

## ACCESSORIES

Inline Weigh Scale (SWL 320kg)	LSS390680	LSS390680	LSS390680	LSS390680	Not Available	Not Available	Not Available
Manual Pivot Frame (SWL 227kg)	Not Available	LSS390670	LSS390670	LSS390670	Not Available	Not Available	Not Available
Powered Pivot Frame (SWL 227kg)	Not Available	LSS390665	LSS390665	LSS390665	Not Available	Not Available	Not Available
Leg Protectors	Not Available	GSP390815 (650mm x160mm)	GSP390815 (650mm x160mm) GSP390816 (750mm x 140mm)	GSP390817 (750mm x 180mm)	GSP390815 (650mm x160mm)	Not Available	Not Available

\*Includes Battery Pack and Handset \*\*Three mast height settings are possible hence the range of minimum and maximums

To view our comprehensive list of spare parts visit [aidacare.com.au](http://aidacare.com.au)

# ASPIRE SLINGS

The Aidacare Aspire range of slings is designed to meet patient needs in the home, aged care and hospital environments.

Manufactured under the highest quality control standards, the extremely durable slings come in a range of fabrics and sizes to suit the individual patient and caregiver's needs.



Size	Girth	Height	SWL
<b>SMALL</b>	65 – 95cm	120 – 160cm	200kg
<b>MEDIUM</b>	77 – 110cm	140 – 175cm	200kg
<b>LARGE</b>	98 – 135cm	158 – 185cm	300kg
<b>X LARGE</b>	118 – 157cm	165 – 193cm	300kg
<b>XX LARGE</b>	155 – 184cm	170 – 193cm	300kg
<b>XXX LARGE</b>	180 – 210cm	170 – 193cm	300kg



## FEATURES



### DURABLE

Loop webbing has a breaking strain in excess of one tonne and is designed so that it will not tangle or “cork-screw” during cleaning



### SERIAL NUMBERED / EMBROIDERED LABEL

Have embroidered labels and a unique serial number to maintain traceability and assist with compliance obligations.



### QUALITY

Manufactured in the UK using European materials, computer guided stitching and CNC fabric cutting



### SERVICE AND MAINTENANCE

Service record labels ensure you can record and identify service history

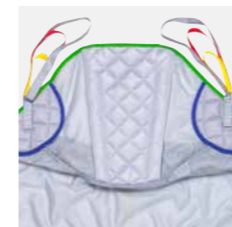

### PATIENT COMFORT

Additional padding in weight bearing areas.



### COLOUR CODED SIZING

All slings have reinforced edging that is colour coded for each size available – making them easy to identify



### MANOEUVRING HANDLES

Thoughtfully positioned handles provide carers with a secure grip point to aid the transfer (Deluxe Low Friction Slings Excepted)



### PATIENT DIGNITY

Option to position strap around the outside of legs for more discreet positioning (applicable models)

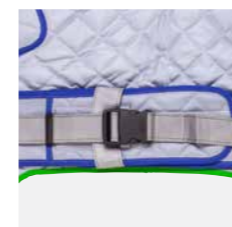

### PATIENT SAFETY

Smart features such as velcro/ buckle combinations for more secure positioning and greater patient safety (applicable models)

## FABRICS

POLYESTER MESH

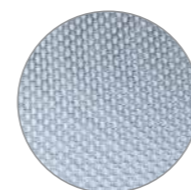

POLYESTER SOLID

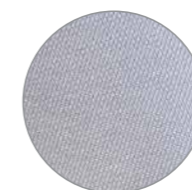

SUPER SOFT

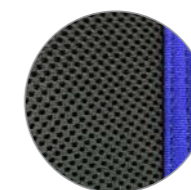

EASY CLEAN

Machine washable up to 85°C

WARRANTY

The Aspire sling range all come with a 12 month warranty

LOOP



## DELUXE GENERAL PURPOSE SLING

Code	Description	Edging	SWL
LSS390700	Polyester – Loop – Small	●	200kg
LSS390705	Polyester – Loop – Medium	●	200kg
LSS390710	Polyester – Loop – Large	●	300kg
LSS390715	Polyester – Loop – X-Large	●	300kg
LS390716	Mesh – Loop – Small	●	200kg
LS390717	Mesh – Loop – Medium	●	200kg
LS390718	Mesh – Loop – Large	●	300kg
LS390719	Mesh – Loop – X-Large	●	300kg

Deluxe General Purpose Sling is registered in the ARTG, AUST R ARTG 224718

LOOP



Clip Option

## DELUXE GENERAL PURPOSE SLING WITH HEAD SUPPORT

Code	Description	Edging	SWL
LSS390740	Polyester – Loop – Small	●	200kg
LSS390745	Polyester – Loop – Medium	●	200kg
LSS390750	Polyester – Loop – Large	●	300kg
LSS390755	Polyester – Loop – X-Large	●	300kg
LSS3907551	Polyester – Loop – XX-Large	●	300kg
LSS3907552	Polyester – Loop – XXX-Large	●	300kg
LSS390756	Mesh – Loop – Small	●	200kg
LSS390757	Mesh – Loop – Medium	●	200kg
LSS390758	Mesh – Loop – Large	●	300kg
LSS390759	Mesh – Loop – X-Large	●	300kg
LSS3907591	Mesh – Loop – XX-Large	●	300kg
LSS3907592	Mesh – Loop – XXX – Large	●	300kg
LSS390900	Polyester – Clip – Small	●	200kg
LSS390905	Polyester – Clip – Medium	●	200kg
LSS390910	Polyester – Clip – Large	●	300kg
LSS390915	Polyester – Clip – X-Large	●	300kg
LSS390916	Mesh – Clip – Small	●	200kg
LSS390917	Mesh – Clip – Medium	●	200kg
LSS390918	Mesh – Clip – Large	●	300kg
LSS390919	Mesh – Clip – X-Large	●	300kg

Deluxe General Purpose Sling is registered in the ARTG, AUST R ARTG 224718

LOOP



Clip Option

## DELUXE LOW FRICTION SLING

Code	Description	Edging	SWL
LSS390880	Parasilk – Loop – Small	●	200kg
LSS390885	Parasilk – Loop – Medium	●	200kg
LSS390890	Parasilk – Loop – Large	●	300kg
LSS390895	Parasilk – Loop – X-Large	●	300kg
LSS390960	Parasilk – Clip – Small	●	200kg
LSS390965	Parasilk – Clip – Medium	●	200kg
LSS390970	Parasilk – Clip – Large	●	300kg
LSS390975	Parasilk – Clip – X-Large	●	300kg

Deluxe Low Friction Sling (Loop) is registered in the ARTG, AUST R ARTG 224720

Deluxe Low Friction Sling (Clip) is registered in the ARTG, AUST R ARTG 224718

LOOP



## DELUXE HYGIENE ACCESS SLING

Code	Description	Edging	SWL
LSS390760	Polyester – Loop – Small	●	200kg
LSS390765	Polyester – Loop – Medium	●	200kg
LSS390770	Polyester – Loop – Large	●	300kg
LSS390775	Polyester – Loop – X-Large	●	300kg
LSS390776	Polyester – Loop – XX-Large	●	300kg
LSS390777	Polyester – Loop – XXX-Large	●	300kg

Deluxe Hygiene Access Sling is registered in the ARTG, AUST R ARTG 224719

LOOP



Clip Option

## DELUXE HYGIENE ACCESS SLING WITH HEAD SUPPORT

Code	Description	Edging	SWL
LSS390780	Polyester – Loop – Small	●	200kg
LSS390785	Polyester – Loop – Medium	●	200kg
LSS390790	Polyester – Loop – Large	●	300kg
LSS390795	Polyester – Loop – X-Large	●	300kg
LSS390940	Polyester – Clip – Small	●	200kg
LSS390945	Polyester – Clip – Medium	●	200kg
LSS390950	Polyester – Clip – Large	●	300kg
LSS390955	Polyester – Clip – X-Large	●	300kg

Deluxe Hygiene Access Sling is registered in the ARTG, AUST R ARTG 224719

SUPERSOFT



MESH



## DELUXE HAMMOCK SLING WITH HEAD SUPPORT

Code	Description	Edging	SWL
LSS390800	Super Soft – Loop – Small	●	200kg
LSS390805	Super Soft – Loop – Medium	●	200kg
LSS390810	Super Soft – Loop – Large	●	300kg
LSS390815	Super Soft – Loop – X-Large	●	300kg
LSS390860	Mesh – Loop – Small	●	200kg
LSS390865	Mesh – Loop – Medium	●	200kg
LSS390870	Mesh – Loop – Large	●	300kg
LSS390875	Mesh – Loop – X-Large	●	300kg

Deluxe Hammock Sling is registered in the ARTG, AUST R ARTG 224720

LOOP



Clip Option

## DELUXE STANDING SLING

Code	Description	Edging	SWL
LSS390720	Loop – Small	●	200kg
LSS390725	Loop – Medium	●	200kg
LSS390730	Loop – Large	●	300kg
LSS390735	Loop – X-Large	●	300kg
LSS390736	Loop – XX-Large	●	300kg
LSS390737	Loop – XXX-Large	●	300kg
LSS390920	Clip – Small	●	200kg
LSS390925	Clip – Medium	●	200kg
LSS390930	Clip – Large	●	300kg
LSS390935	Clip – X-Large	●	300kg

Deluxe Standing Sling is registered in the ARTG, AUST R ARTG 224698

LOOP



## HYBRID PATIENT SLING

Code	Description	Edging	SWL
LSS390830	Small	<span style="color: red;">●</span>	200kg
LSS390835	Medium	<span style="color: yellow;">●</span>	200kg
LSS390840	Large	<span style="color: green;">●</span>	300kg
LSS390845	X-Large	<span style="color: blue;">●</span>	300kg

Hybrid Patient Sling is registered in the ARTG, AUST R ARTG 306027

LOOP



## SINGLE USE PATIENT SLING

Code	Description	Edging	SWL
LSS391100	Small	<span style="color: red;">●</span>	200kg
LSS391110	Medium	<span style="color: yellow;">●</span>	200kg
LSS391120	Large	<span style="color: green;">●</span>	200kg
LSS391130	X-Large	<span style="color: blue;">●</span>	200kg

Single Use Patient Sling is registered in the ARTG, AUST R ARTG 306027

# ASSOCIATED PRODUCTS AND SERVICES



## CEILING HOISTS

Ceiling hoists are secured to the ceiling of a room and work as a lifting system. They allow the hoist to move around the room on tracks and help patients get from one point to another.

This method of transfer is gentle on both the patient and their carer.

Shown Prism Transactive Xtra ceiling hoist - various models available.

## AIDACARE SLING AUDITING

### Old Slings? Don't risk it.

An old, worn out or faulty sling could be a significant safety risk for your organisation.

Aidacare's Sling Audit Program can assist you to ensure your sling inventory is in safe working order at all times.

Periodic sling audits are now a mandatory accreditation requirement. Ask us how we can help you manage the risk in this area of your business.

