



back to sleep®  
the bedding & mobility specialists

# ROHO® Products

Built for the real you.



permobil



Keep moving  
as you do; we'll  
follow your lead.



## Table of Contents

	Page
<b>Science Behind ROHO®</b>	4-6
<b>Seat Cushions</b>	
Select Series	8-9
Smart Series	10-11
Hybrid Series	12-13
Custom	14-15
Single Compartment	16-17
Dual Compartment	18-19
Other Cushioning Products	20-21
Specialty and Accessory Products	22-25
Mattress Products	27-28
<b>Wheelchair Back Systems</b>	
ROHO AGILITY Standard Series	30-33
ROHO AGILITY Active Series	34-35
<b>Resources</b>	
Measurement Instructions	36-37
Cushion Sizing Charts	38
Back Sizing Charts	39-40
Product Use and Maintenance	41
Returns, Warranty and Quality Management	41
EC Statement and Trademarks	42

# SCIENCE BEHIND ROHO PRODUCTS

---

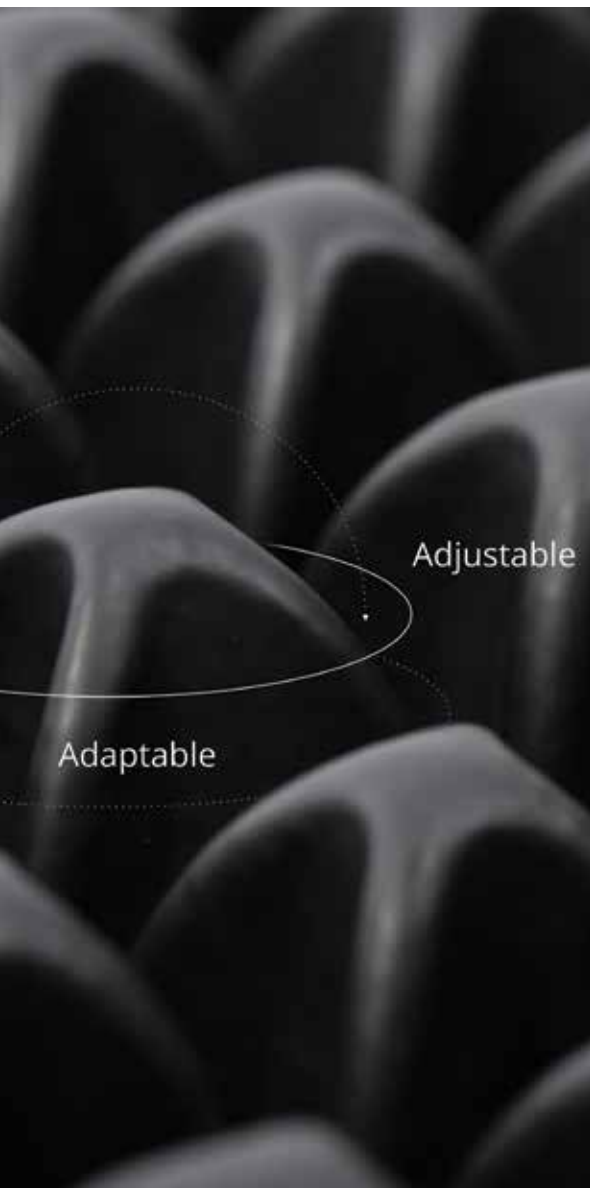

Pressure injuries can be a painful and debilitating medical complication, and under unfavorable circumstances, can develop within minutes to hours. However, preventing their occurrences is feasible through early recognition and intervention.

One of the intervening technologies that Permobil Seating & Positioning uses to combat pressure injuries is called **ROHO® Shape Fitting Technology®**. The unique air-cell design of the ROHO product range has the capability to conform and adapt to the user's body shape, mimicking the pressure redistribution properties of water. This conformity reduces the effects of friction and shear on tissue, which are the primary factors in pressure injury formation.

For anyone whose health, well-being or recovery depends on skin protection and positioning, products using **ROHO® Shape Fitting Technology®** provide comfort and support through pressure injury prevention and healing.

Demand ROHO products for the best clinical outcomes.

- Superior skin and soft tissue protection
- Longer safe sitting times
- Positioning and stability capabilities

## Recommend the Best Cushion – Backed by Clinical Evidence

Permobil has been validated by industry clinicians and scientists for over 40 years. With decades of experience in the market and over 90 scientific and clinical studies, Permobil is the efficacy and outcomes expert.



ZERO COMPETITION with this Magnitude of Evidence-Based Research!

With over 1 million ROHO products in use in over 65 countries worldwide, you can be confident in using ROHO products.

ROHO products are unique in their capability to conform and adapt to the body's shape. No other product has DRY FLOATATION® Technology to evenly distribute the forces of body weight and reduce the effects of friction and shear on tissue. DRY FLOATATION® Technology creates the ideal healing environment by minimizing soft tissue deformation while maintaining blood flow.

Time and time again, studies have proven that ROHO cushions are the optimal choice for preventing and treating pressure injuries and post-operative wounds.

**Quality and efficacy are the key foundations of Permobil.** To ensure that ROHO products continue to achieve the best clinical outcomes, Permobil has dedicated extensive resources toward building industry-leading clinical research for ROHO products. To continuously improve and stay above the competition, Permobil has formed a Scientific Advisory Board for Pressure Injury which is composed of an esteemed group of subject matter experts. Their efforts and research drive the company from research and development through training and education.

### ROHO® Cushions:

Significantly more effective than flat reference foam\* in reducing the risk of tissue damage.\*\*

- 41%** decrease in tissue stress from the intimate way they conform to the body.\*\*
- 57%** better immersion than flat reference foam\* to protect the tissues from further risk posed by disuse-related changes, including muscle atrophy, bone shape adaptations, spasms, obesity and scarring.\*\*

\*Reference foams were assumed to be isotropic linearelastic with Poisson's ratio of 0.3 and elasticmoduli of 7 or 10 kPa

\*\*Gefen, et al. (JVT 2014)

# Discover the Four Fundamentals of DRY FLOATATION® Technology

ROHO DRY FLOATATION Technology is based on hydrostatics (the study of disparate conditions in a liquid such as water). The technology follows four principles for ensuring skin protection and comfort.

## Let's You In (Low Surface Tension)

*Definition: The ability of the surface to yield easily upon contact.*

Our unique design lets you easily sink into the cushion, reducing pressure and discomfort to your skin and soft tissues.

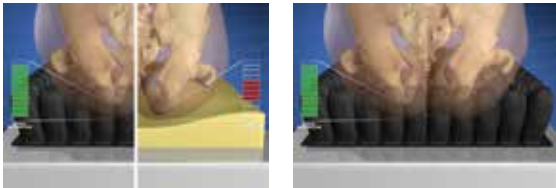

## Matches Your Shape (Constant Restoring Forces)

*Definition: Fluid flotation provides even and constant forces at all points of contact.*

Your shape is unique. A ROHO cushion constantly conforms and adapts to you and can be adjusted to your body changes over time.

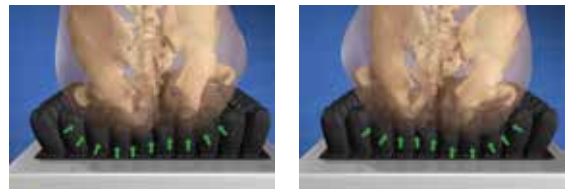

## Moves With You (Six Degrees of Freedom)

*Definition: The freedom of movement in all directions.*

No matter what you are doing, your ROHO cushion will adapt to your every position throughout the day and over time. The air cells follow your motions, giving you support and freedom of movement.

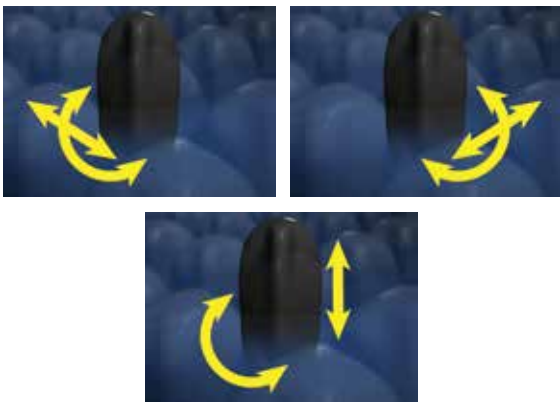

## Works With You, Not Against You (Low Friction and Shear)

*Definitions: Friction is the resistance of movement between two surfaces. Shear is the result of materials or tissues being pulled in opposite directions.*

Nothing feels like a ROHO cushion. The smooth surface reduces shear and friction without compromising your safety and comfort.

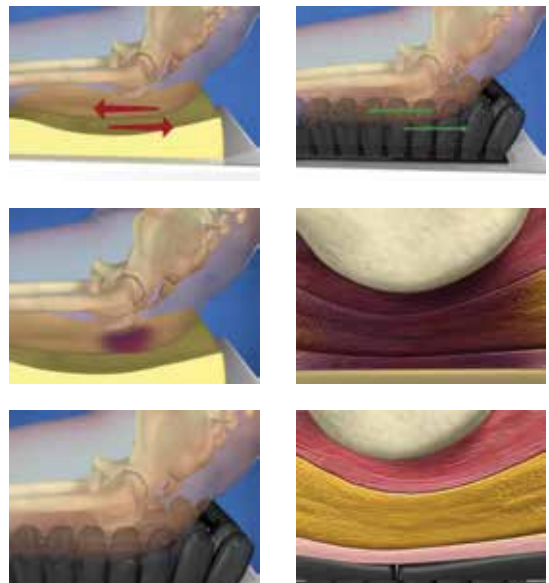



# SEAT CUSHIONS

---

ROHO cushions are built for the real you, no matter who you are or where you sit. The proprietary air cell technology keeps you in place while moving as you do, constantly adjusting to your body.



Select Series

Smart Series

Hybrid Series

Custom

Single Compartment

Dual Compartment

Other Cushioning Products

Specialty and Accessory Products





## Select Series

The QUADTRO SELECT® and CONTOUR SELECT® cushions feature four independent compartments of air cells for an individualized fit, each controlled by our exclusive ISO-FLO® Memory Control.

ROHO's ISO-FLO® Memory Control, located at the front of all Select Series cushions, allows air to flow through the cushion in two ways:



**ISO-FLO Memory Control shown in the OPEN position.**

Air can flow freely throughout the entire cushion, similar to a ROHO Single Compartment Cushion.



**ISO-FLO Memory Control shown in the CLOSED position.**

Air becomes locked into four separate quadrants, offering front-to-back and side-to-side positioning capabilities.

Every Select Series cushion sets the standard for skin and soft tissue protection, without compromising stability, positioning, comfort or ease of use.

Featuring DRY FLOATATION® air cells, the Select Series assists in pressure injury prevention and treatment.



# QUADTRO SELECT® CUSHIONS



## HIGH PROFILE®

The tall interconnected air cells envelop your body, delivering maximum immersion for the ultimate in skin protection, positioning, stability and comfort.

### IDEAL FOR PEOPLE WHO

Require accommodation or correction of front-to-back or side-to-side pelvic asymmetries, up to approx. 3 in. (7.5 cm)

Require pelvic and lower extremity positioning

### DIMENSIONS

Width: 12.75 in. to 26.25 in. / 32.5 cm to 67 cm  
Depth: 11.75 in. to 67 in. / 30 cm to 51.5 cm  
Height: 4.25 in. / 10.5 cm

### LIMITED WARRANTY

Cushion: 36 months  
Cover: 6 months

### WEIGHT LIMIT

No weight limit



## MID PROFILE™

The mid-sized interconnected air cells deliver the ideal combination of customizable positioning and stability.

### IDEAL FOR PEOPLE WHO

Require accommodation or correction of front-to-back or side-to-side pelvic asymmetries, up to approx. 2 in. (5 cm)

Require pelvic and lower extremity positioning

### DIMENSIONS

Width: 14.5 in. to 19.5 in. / 36.5 cm to 49.5 cm  
Depth: 13.5 in. to 18.5 in. / 34.5 cm to 47 cm  
Height: 3.25 in. / 8.5 cm

### LIMITED WARRANTY

Cushion: 36 months  
Cover: 6 months

### WEIGHT LIMIT

No weight limit



## LOW PROFILE®

The interconnected air cells deliver sitting stability. It could be used as a secondary cushion, on an office chair, in adaptive sports equipment, in a car or anywhere else you may need cushioning and protection.

### DIMENSIONS

Width: 11 in. to 24.25 in. / 28 cm to 62.5 cm  
Depth: 11.75 in. to 22 in. / 30 cm to 56 cm  
Height: 2.25 in. / 5.5 cm

### LIMITED WARRANTY

Cushion: 36 months  
Cover: 6 months

### WEIGHT LIMIT

No weight limit

# CONTOUR SELECT®



Designed for positioning and posture, this cushion helps to keep you centered in the cushion in an upright pelvic posture.

- Provides leg alignment and pelvis stabilization
- Provides further individualization of side-to-side and front-to-back positioning with ISOFLO® Memory Control
- Stability
- Positioning

### DIMENSIONS

Width: 14.5 in. to 24.25 in. / 36.5 cm to 62.5 cm  
Depth: 15.25 in. to 20.25 in. / 38.5 cm to 51.5 cm  
Height: Approx. 2.25 in. to 4.25 in. / 5.5 cm to 10.5 cm  
Range due to varying heights of cells

### LIMITED WARRANTY

Cushion: 36 months  
Cover: 6 months

### WEIGHT LIMIT

No weight limit



## Smart Series

### Smart Check®

Personal Electronic Cushion Security Device

Meet Smart Check. It's the brains behind the most effective and user friendly electronic cushion monitoring system on the market.

After performing a setup with the Smart Check, simply attach the portable Smart Check device to your ROHO Sensor Ready cushion, press the check button, and you'll know right away if your inflation level has changed.

Limited Warranty: 24 Months

- Stores recommended inflation range
- Press to check inflation level
- Real-time feedback
- Ability to reset
- Detachable for storage





**HIGH PROFILE®**  
**Single Compartment Sensor Ready Cushion**

The tall, interconnected individual air cells envelop you to redistribute pressures and decrease friction and shear.

These taller air cells provide a greater contact area and maximum immersion and envelopment – which promotes healing.

---

**IDEAL FOR PEOPLE WHO**

Require accommodation of pelvic asymmetry, up to 3 in. / 7.5 cm

**DIMENSIONS**

Width: 11.5 in. to 26.75 in. / 29 cm to 68 cm

Depth: 11.5 in. to 20 in. / 29 cm to 50.5 cm

Height: 4.25 in. / 10.5 cm

**LIMITED WARRANTY**

Cushion: 24 months

Cover: 6 months

**WEIGHT LIMIT**

No weight limit



**MID PROFILE™**  
**Single Compartment Sensor Ready Cushion**

The individual midsize air cells provide the ideal level of immersion and skin protection, thanks to the Shape Fitting Technology® of ROHO DRY FLOATATION®.

The shape and depth of the cells adapt to your movements and conform to your body's changes throughout the day.

---

**IDEAL FOR PEOPLE WHO**

Require accommodation of pelvic asymmetry, up to 2 in. / 5 cm

**DIMENSIONS**

Width: 13.25 in. to 23.5 in. / 33.5 cm to 59.5 cm

Depth: 13.25 in. to 20 in. / 33.5 cm to 50.5 cm

Height: 3.25 in. / 8 cm

**LIMITED WARRANTY**

Cushion: 24 months

Cover: 6 months

**WEIGHT LIMIT**

No weight limit



**HYBRID ELITE SR™**  
**Single Compartment Cushion**

This innovative cushion combines the skin and soft tissue protection from the Shape Fitting Technology™ of an air-filled ROHO DRY FLOATATION® Cushion with stability and positioning from a contoured foam base.

The shape-fitting air insert provides critical pressure redistribution around the pelvic area.

---

**IDEAL FOR PEOPLE WHO**

Require accommodation of pelvic asymmetry, up to 2 in. / 5 cm

Require pelvic and lower extremity positioning and a more stable environment for transfers

**DIMENSIONS**

Width: 13.75 in. to 23.75 in. / 35 cm to 60.5 cm

Depth: 14.75 in. to 20.75 in. / 37.5 cm to 53 cm

Height: 4.25 in. / 11 cm

**WEIGHT LIMIT**

500 lbs. / 225 kg



## Hybrid Series

These innovative cushions combine the skin and soft tissue protection from the Shape Fitting Technology™ of an air-filled ROHO DRY FLOATATION™ Insert with the stability of a contoured foam base.

The contoured foam base is designed to allow for increased stability for transfers and provides exceptional comfort, positioning and stability.

- Combination of air and foam for stability and skin/soft tissue protection
- Contoured foam provides lateral and medial upper leg supports to hold your legs in place
- Firm base for transfers
- Supports pressure injury prevention and treatment





**Hybrid Elite SR™**  
Single Compartment Cushion

This innovative cushion combines the skin and soft tissue protection from the Shape Fitting Technology of an air-filled ROHO DRY FLOATATION® Cushion with stability from a contoured foam base.

The shape-fitting air insert provides critical pressure redistribution around the pelvic area.

---

**IDEAL FOR PEOPLE WHO**

- Require accommodation of pelvic asymmetry, up to 2 in. / 5 cm
- Require pelvic and lower extremity positioning
- Require a more stable base for transfers

**DIMENSIONS**

- Width: 13.75 in. to 23.75 in. / 35 cm to 60 cm
- Depth: 14.75 in. to 20.75 in. / 37.5 cm to 53 cm
- Height: 4.25 in. / 11 cm

**LIMITED WARRANTY**

- Cushion: 24 months
- Cover: 6 months

**WEIGHT LIMIT**

500 lbs. / 225 kg



**Hybrid Elite**  
Dual Compartment Cushion

Combines the skin and soft tissue protection and Shape Fitting Technology of a ROHO DRY FLOATATION® Cushion with the stability of a contoured foam base.

The dual compartment air insert provides critical pressure redistribution around the pelvis. The two independent, adjustable air compartments let you set inflation levels to reduce or accommodate a side-to-side asymmetry, such as a pelvic obliquity.

---

**IDEAL FOR PEOPLE WHO**

- Require accommodation or correction of pelvic asymmetry, up to 2 in. / 5 cm
- Need side-to-side positioning
- Require a more stable environment for transfers

**DIMENSIONS**

- Width: 14 in. to 20 in. / 35.5 cm to 51 cm
- Depth: 14.75 in. to 20.75 in. / 37.5 cm to 53 cm
- Height: 4.25 in. / 11 cm

**LIMITED WARRANTY**

- Cushion: 24 months
- Cover: 6 months

**WEIGHT LIMIT**

500 lbs. / 225 kg



**Nexus SPIRIT®**

ROHO DRY FLOATATION® Technology combined with the stability of a soft, contoured foam base.

This base provides stability and positioning and support when transferring. The individual air cells envelop your body, providing pressure relief and helping to prevent skin and soft tissue breakdown.

---

**IDEAL FOR PEOPLE WHO**

- Require accommodation of pelvic asymmetry, up to approx. 1 in. / 2.5 cm
- Need transfer stability and support
- Need a combination of air and foam for positioning

**DIMENSIONS**

- Width: 14 in. to 20 in. / 35.5 cm to 51 cm
- Depth: 15.5 in. to 19.5 in. / 39.5 cm to 49.5 cm
- Air Insert Height: 2.25 in. / 5.5 cm
- Total Height: 3.5 in. / 9 cm

**LIMITED WARRANTY**

- Cushion: 24 months
- Cover: 6 months

**WEIGHT LIMIT**

No weight limit



## Custom Cushions

Together with your clinician or distributor, you can design your own ROHO Cushion – and we'll build it.





We understand that there's no such thing as one size fits all when it comes to comfort, safety and health. That's why ROHO® cushions are available in fully customizable shapes, sizes and functions.

---

**IDEAL FOR PEOPLE WHO**

Need to vary the number of valves or compartments to provide side-to-side and front-to-back positioning

Would benefit from varying cell heights to provide stability, positioning and skin/soft tissue protection exactly where it's needed

Need to add or delete rows of cells beyond the dimensions of standard size models

Need to remove cells or rows

Would benefit from adding ventilation/drainage holes through base of cushion

**DIMENSIONS**

CUSTOM

**LIMITED WARRANTY**

Cushion: 24 months

Cover: 6 months

**WEIGHT LIMIT**

Custom

Custom Cushions are designed and priced upon request. Restrictions may apply.

Please contact Customer Support at [orders.roho@permobilus.com](mailto:orders.roho@permobilus.com), or call (618) 277-9150. The Design-A-ROHO worksheet is also available on [permobilus.com](http://permobilus.com).



## Single Compartment Cushions

DRY FLOATATION® technology redistributes pressure while decreasing friction and shear. Every Single Compartment Series cushion is fully adjustable to fit your shape, minimize tissue deformation and facilitate blood flow.

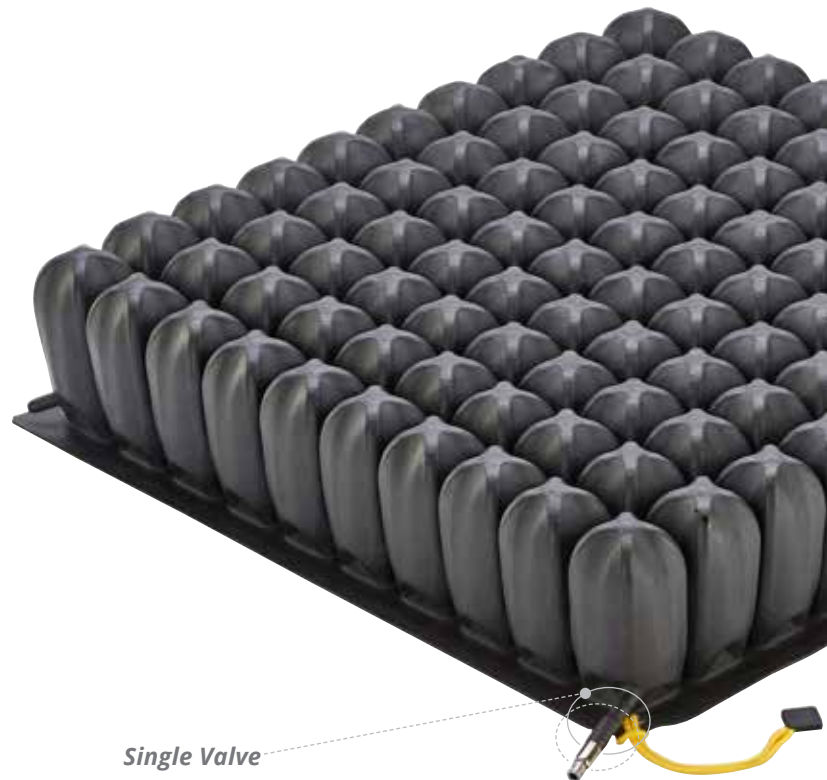

Single Valve





## HIGH PROFILE®

The tall individual air cells provide maximum immersion and envelopment to redistribute pressure and decrease friction and shear. With a simple inflation adjustment, your ROHO will conform to your exact shape to minimize tissue deformation and maximize blood flow.

---

### IDEAL FOR PEOPLE WHO

Require accommodation or correction of pelvic asymmetry, up to approx. 3 in. / 7.5 cm

Need skin protection, maximum immersion and envelopment

### DIMENSIONS

Width: 11.5 in. to 26.75 in. / 29 cm to 68 cm  
Depth: 11.5 in. to 25 in. / 29 cm to 63.5 cm  
Height: 4.25 in. / 10.5 cm

### LIMITED WARRANTY

Cushion: 24 months  
Cover: 6 months

### WEIGHT LIMIT

No weight limit



## MID PROFILE™

The mid-sized individual air cells bring a balance between immersion and stability while redistributing pressure and decreasing friction and shear. With a simple inflation adjustment, your ROHO conforms to your shape, minimizing tissue deformation and maximizing blood flow.

---

### IDEAL FOR PEOPLE WHO

Require accommodation or correction of pelvic asymmetry, up to approx. 2 in. / 5 cm

Need skin protection, immersion and envelopment

### DIMENSIONS

Width: 13.25 in. to 20 in. / 33.5 cm to 50.5 cm  
Depth: 13.25 in. to 20 in. / 33.5 cm to 50.5 cm  
Height: 3.25 in. / 8.5 cm

### LIMITED WARRANTY

Cushion: 24 months  
Cover: 6 months

### WEIGHT LIMIT

No weight limit



## LOW PROFILE®

Designed for those with active lifestyles, the shorter interconnected air cells reduce friction and shear as you move your cushion.

The LOW PROFILE could be used as a secondary cushion on an office chair, in the car or in the bath – anywhere you need extra cushioning and protection from injury.

---

### DIMENSIONS

Width: 11.5 in. to 23.5 in. / 29 cm to 59.5 cm  
Depth: 11.5 in. to 20 in. / 29 cm to 50.5 cm  
Height: 2.25 in. / 5.5 cm

### LIMITED WARRANTY

Cushion: 24 months  
Cover: 6 months

### WEIGHT LIMIT

No weight limit



## Dual Compartment Cushions

Two separate compartments with independently adjusted air inflation levels bring a unique level of stability and positioning to the skin/soft tissue protection of the DRY FLOATATION® Technology.





## ENHANCER®

The multiple cell heights are contained within two independent compartments (one consisting of the ischial well and leg trough cells, the other consisting of the lateral and medial thigh supports). This helps to keep the pelvis and legs in position and provides stability, while still providing optimal skin and soft tissue protection.

The ENHANCER Cushion is the only ROHO cushion that allows you to isolate the ischial well and increase the lateral support in the greater trochanter area.

---

### IDEAL FOR PEOPLE WHO

Require positioning of the pelvis and lower extremities

Need increased lateral support

Need to partially offload the ischial tuberosities

### DIMENSIONS

Width: 14.75 in. to 20 in. /

37.5 cm to 50.5 cm

Depth: 14.75 in. to 20 in. /

37.5 cm to 50.5 cm

Height: 2.25 in. to 4.25 in. /

5.5 cm to 10.5 cm

(Range due to varying cell heights)

### LIMITED WARRANTY

Cushion: 24 months

Cover: 6 months

### WEIGHT LIMIT

No weight limit

HIGH PROFILE and LOW PROFILE Dual Compartment cushions give you the ability to independently adjust right and left compartment inflation levels to reduce or accommodate side-to-side pelvic asymmetries. The end result is improved positioning and stability along with protection from pressure injuries.

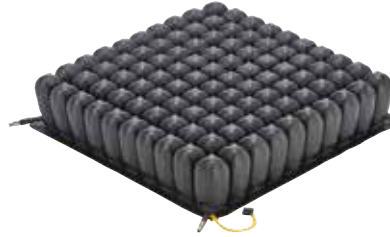

## HIGH PROFILE®

Each compartment of the HIGH PROFILE Dual compartment cushion can be adjusted independently to increase positioning and stability by addressing side-to-side asymmetries, such as a pelvic obliquity.

---

### IDEAL FOR PEOPLE WHO

Require accommodation or correction of pelvic asymmetry, up to approx. 3 in. / 7.5 cm

### DIMENSIONS

Width: 14.75 in. to 20 in. /

37.5 cm to 50.5 cm

Depth: 14.75 in. to 21.75 in. /

37.5 cm to 55 cm

Height: 4.25 in. / 10.5 cm

### LIMITED WARRANTY

Cushion: 24 months

Cover: 6 months

### WEIGHT LIMIT

No weight limit

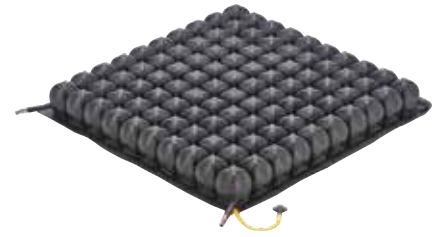

## LOW PROFILE®

Assists in providing stability across the cushion, even if you have pelvic asymmetry or other challenges with posture. Designed for people with an increased activity level who may need positioning as they lean from side to side.

The LOW PROFILE could be used as a secondary cushion, on an office chair, in adaptive sport equipment, in the car or anywhere you need extra cushioning and protection.

---

### DIMENSIONS

Width: 14.75 in. to 20 in. /

37.5 cm to 50.5 cm

Depth: 14.75 in. to 20 in. /

37.5 cm to 50.5 cm

Height: 2.25 in. / 5.5 cm

### LIMITED WARRANTY

Cushion: 24 months

Cover: 6 months

### WEIGHT LIMIT

No weight limit



## Other Cushioning Products

At Permobil, we're always looking to feature the widest range of products to offer solutions for everyone.



AIR FLOATATION air insert built into the AirLITE® cushion.

## AirLITE® Cushion

The AirLITE is a maintenance-free cushion. The soft, comfortable foam base with the built-in, nonadjustable AIR FLOATATION® air insert allows the cushion to conform to your body while also preventing you from bottoming out in your wheelchair. The gentle contour of the leg trough helps you maintain the right position and posture.

- Maintenance-free
- Comfort
- Lightweight
- Positioning
- Stability

---

### DIMENSIONS

Width: 13 in. to 20 in. / 33 cm to 51 cm  
 Depth: 13 in. to 20 in. / 33 cm to 51 cm  
 Height: Approx. 2 in. to 3.75 in. / 5 cm to 9.5 cm

### LIMITED WARRANTY

Cushion: 24 months

### WEIGHT LIMIT

300 lbs. / 136 kg



## MOSAIC® Cushion

The re-engineered, cost-effective MOSAIC Cushion is now even better. With a more comfortable fit, you'll enjoy more sitting time while still protecting your skin and soft tissues.

With the mild contour and more effective, controlled air flow, you can sit longer, with less pain, knowing you have proven ROHO air-cell-based technology supporting you.

The innovative design of the MOSAIC cushion allows you to sink comfortably into it and shapes to the unique contours of your body. Available in an expanded range of sizes to better fit your seating surface, MOSAIC provides basic preventative skin and soft tissue protection at an affordable price.

---

### DIMENSIONS

Width: 16.25 in. to 20.25 in. / 41.5 cm to 51.5 cm  
 Depth: 16.25 in. to 18.25 in. / 41.5 cm to 46.5 cm  
 Height: Approx. 2.25 in. to 3 in. / 6.5 cm to 7.5 cm

### LIMITED WARRANTY

Cushion: 12 months

### WEIGHT LIMIT

315 lbs. / 143 kg



## LTV® Seat Cushion

The LTV is a nonmedical cushion application for anyone who sits for extended periods of time. Lightweight and foldable, it delivers unmatched comfort and convenience.

The interconnected cells transfer air from chamber to chamber as you shift your weight to distribute pressure across the cushion.

The LTV cushion has two cover options—Quilted Fabric or ULTRA LEATHER®.

---

### DIMENSIONS

Width: 18 in. / 45.5 cm  
 Depth: 16 in. / 40.5 cm  
 Height: 1 in. to 2 in. / 2.5 cm to 5.5 cm  
 Weight: 1 lbs. / 0.2 kg

### LIMITED WARRANTY

Cushion: 12 months



## Specialty Products and Accessories

Of course, the risks to your health don't go away if you're out of your wheelchair. Pressure injuries and discomfort can happen anywhere.

That's why Permobil has developed innovative products to keep you protected, wherever you go.

Toilet Seat Cushion

Shower/Commode Cushion

HEAL PAD® Cushion

Lumbar Support Cushion

ADAPTOR® PAD

MINI-MAX® Cushion

ROHO® PLANAR SOLID SEAT INSERT



## Toilet Seat Cushion

The adjustable, air-filled cellular neoprene surface is designed for short-term use on toilets and portable bedside commodes. It snaps easily into place and is easy to clean and disinfect.

- Quickly snaps into place
- Adjustable
- Easy to clean and disinfect

### DIMENSIONS

Width: 7.75 in. / 20 cm  
 Depth: 15.75 in. / 40 cm  
 Height: 2.25 in. / 5.5 cm  
 Weight: 1.25 lbs. / 0.5 kg

### LIMITED WARRANTY

24 months

### WEIGHT LIMIT

No weight limit



## HEAL PAD® Cushion

Place your foot in an adjustable, therapeutic environment that reduces shear and friction on your heel. By supporting the most high-risk pressure points, the pad protects you from injury and facilitates healing.

- Available in singles and pairs

### DIMENSIONS

Width: 11.5 in. / 29.5 cm  
 Depth: 12.5 in. / 31.5 cm  
 Height: 1.5 in. / 4 cm  
 Weight: 0.75 lbs. / 0.9 kg

### LIMITED WARRANTY

24 months



## Shower/Commode Cushion

Using ROHO's exclusive DRY FLOATATION® Technology, the adjustable, air-filled Shower/Commode cushion provides much-needed cushioning and protection for bedside commodes and shower wheelchairs. Designed for use without a cover, the cushion is easy to clean and disinfect.

- Easy to clean and disinfect

### DIMENSIONS

Width: 14.75 in. to 18.25 in. / 37.5 cm to 46.5 cm  
 Depth: 14.75 in. to 18.25 in. / 37.5 cm to 46.5 cm  
 Height: 2.25 in. / 5.5 cm  
 Weight: 1.5 lbs. / 0.7 kg

### LIMITED WARRANTY

24 months

### WEIGHT LIMIT

24 months



## Lumbar Support Cushion

Supporting the lumbar spine, the adjustable cushion uses DRY FLOATATION® Technology for positioning and skin and soft tissue protection. Easily installed using the included hook-and-loop fasteners, it can be used in your wheelchair, recliner or office wheelchair.

### DIMENSIONS

Width: 15.25 in. / 39 cm  
 Depth: 6.5 in. / 16 cm  
 Height: 4.25 in. / 10.5 cm  
 Weight: 1 lb. / 0.5 kg

### LIMITED WARRANTY

24 months



## ADAPTOR® PAD

Turn any flat or contoured surface into a cushioned, protective environment. The air cells are not linked; it's designed to protect other pressure points. It can be cut to fit armrests, trays, footrests or anywhere protection is needed.

- Individually sealed air cells
- Can be cut to size
- Absorbs shock

---

### DIMENSIONS

Width: 9.75 in. / 25 cm  
Depth: 13.5 in. / 34 cm  
Height: 1 in. / 2 cm  
Weight: 0.5 lbs. / 0.2 kg

### LIMITED WARRANTY

24 months

### WEIGHT LIMIT

No weight limit



## ROHO® Privacy Shield

for anyone who wants coverage between the bottom of the back of their wheelchair and the seat base of their wheelchair.

Unlike other privacy shields on the market, the ROHO Privacy Shield is designed to attach directly to the canes, so it will work with most wheelchairs. It is easy to attach and detach for cleaning.

---

### LIMITED WARRANTY

6 months

\*This is a non-medical product



## MINI-MAX® Cushion

Designed for short-term use during recreational and sport activities, bathing, traveling, etc. Provides shock and impact absorption, as well as skin protection. The air-filled cells are fully adjustable.

- Comfortable

---

### DIMENSIONS

Width: 15 in. to 18.25 in.  
38.5 cm to 46.5 cm  
Depth: 14.75 in. to 16 in.  
37.5 cm to 40.5 cm  
Height: 1.25 in. / 3 cm  
Weight: 2 lbs. / 0.9 kg

### LIMITED WARRANTY

Cushion: 24 months  
Cover: 6 months

### WEIGHT LIMIT

No weight limit



## ROHO® Planar Solid Seat Insert

The ROHO Planar Solid Seat Insert provides a solid base for use with ROHO cushioning products. The base provides support to assist with positioning. Made of polyurethane coated birch plywood, the .3 cm (3/8 in.) base easily fits under the cushion, inside the ROHO cushion cover.

- Eliminates the hammock effect of sling seats

---

### LIMITED WARRANTY

12 months





## ROHO® Standard and SELECT Series Cushion Replacement Covers

The ROHO Standard and SELECT Series Cushion Replacement Covers are intended to protect the cushion. Features include a two-way stretch top, spacer fabric sides with a zipper, and a non-skid bottom with hook and loop fasteners to help secure the cushion in the wheelchair.

---

### LIMITED WARRANTY

6 months

Note: SELECT Series cushion covers include an opening for the ISOFLO Memory Control.



## ROHO® Heavy Duty Cushion Covers

The ROHO Heavy Duty Cushion Cover is a fluid-resistant cover intended to protect the cushion. Features include a two-way stretch, fluid-resistant top and sides with a zipper, and a non-skid bottom with hook and loop fasteners to help secure the cushion in the wheelchair.

The ROHO Heavy Duty Cushion Cover is recommended for individuals who:

- Seek additional resistance to everyday wear and tear
- Seek additional incontinence protection for cushion
- Seek ozone protection for cushion

---

### LIMITED WARRANTY

6 months

ROHO® Standard Cushion Covers and Heavy Duty Cushion Covers are available for the following cushions:

### ROHO Single or Dual Compartment:

- HIGH PROFILE
- MID PROFILE
- LOW PROFILE
- HIGH PROFILE Sensor Ready Cushion
- MID PROFILE Sensor Ready Cushion
- ENHANCER
- MOSAIC

### ROHO Select Series Covers for:

- QUADTRO SELECT HIGH PROFILE
- QUADTRO SELECT MID PROFILE
- QUADTRO SELECT LOW PROFILE
- CONTOUR SELECT

NOTE: The Select Cushion Covers include an opening for the ISOFLO Memory Control for Standard Cushion Covers.

## Replacement covers are available for the following cushions:

ROHO Single or Dual Compartment:

- Hybrid Elite Cushion Cover
- Hybrid Elite SR Cushion Cover
- HARMONY Cushion Cover
- Nexus SPIRIT Cushion Cover
- MINI-MAX® Cushion Cover
- PACK-IT® Cushion Cover
- AirLITE Cushion
- LTV Seat Cushion

## ROHO Cushion Cover with Pocket

Need a place to keep your keys, wallet, or glasses? The ROHO Cushion Cover with Pocket puts it all within arm's reach.

This product is made to order, so please allow 3-4 weeks for delivery.



## STILL LOOKING FOR THE RIGHT CUSHION FOR YOU?

We never underestimate the importance of finding the perfect fit.

Visit [permobilus.com](http://permobilus.com) to:

- Locate a dealer near you
- Find more detailed product information
- Learn more about the clinical evidence and technology supporting the development of ROHO products
- Watch how-to videos

Our Customer Support department is also standing by to help you find the support you need. Contact us at (800) 851-3449 or (618) 277-9150. They can also be reached by email at: [orders.roho@permobil.com](mailto:orders.roho@permobil.com).

# Mattress Products

The air-filled mattress overlays are a great solution for skin and soft tissue protection in hospitals, long-term care or even home care settings.

The interconnected, adjustable air cells conform to the contours of the body to minimize tissue deformation and promote healing. ROHO Mattress Overlay's are non-powered, so they can maintain inflation and protection levels - even during power outages or any situation where power is not easily accessible.



## ROHO DRY FLOATATION Mattress Overlay System

The DRY FLOATATION Mattress Overlay mimics the pressure redistributing properties of water, creating the ideal environment for pressure injury prevention and healing.

The DRY FLOATATION Mattress Overlay is not dependent on an electrical air pump and thus it produces no sound, heat or vibrations. This overlay is also modular and each of the four sections can be adjusted.

- Adjustable for size and weight change
- Provides 2.75 in / 7 cm of immersion
- Drainage holes
- Four independent sections

### IDEAL FOR PEOPLE WHO

At risk for skin/soft tissue breakdown and/or deep tissue injury

Require pressure injury prevention and treatment

Require a mattress overlay that provides an individualized fit

### DIMENSIONS

Width: 33.75 in. / 86 cm

Depth: 75 in. / 190.5 cm

Height: 3.25 in. / 8.5 cm

Weight: 32 lbs / 14.5 kg

### LIMITED WARRANTY

Mattress Overlay: 24 months

Cover: 6 months

### WEIGHT LIMIT

No weight limit

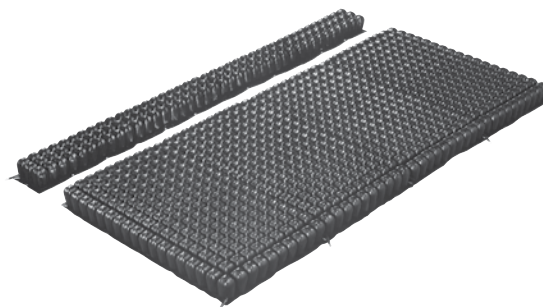

## ROHO DRY FLOATATION Bariatric Kit

These add-on sections extend the width of your the DRY FLOATATION Mattress Overlay, to fit larger bed sizes.

### AVAILABLE DIMENSIONS

75 in. x 40 in. x 3.3 in. /  
190.5 cm x 100.5 cm x 8.5 cm

75 in. x 41.3in. x 3.3 in. /  
190.5 cm x 105.5 cm x 8.5 cm

75 in. x 48.4 in. x 3.3 in. /  
190.5 cm x 123 cm x 8.5 cm

75 in. x 54.3 in. x 3.3 in. /  
190.5 cm x 138.5 cm x 8.5 cm

75 in. x 59.8 in. x 3.3 in. /  
190.5 cm x 152.5 cm x 8.5 cm

Custom sizing options available

### LIMITED WARRANTY

Mattress: 2 years

### WEIGHT LIMIT

No weight limit



## ROHO SOFFLEX 2 Mattress Overlay System

The adjustable, AIR FLOATATION air cells are designed to conform to the body shape, redistributing the weight across the surface. The three individual sections can be independently adjusted to address specific support needs.

The SOFFLEX 2 Mattress Overlay is not dependent on an electrical air pump and thus it produces no sound, heat or vibrations.

The polyurethane SOFFLEX 2 Mattress Overlay is available with an enclosure cover or a reusable cover.

- Adjustable for size and weight change
- Adjustable to changes in individual's position over time
- Provides 3 in / 7.5 cm of immersion
- Easy to clean and disinfect

---

### IDEAL FOR PEOPLE WHO

Requires a mattress overlay that provides an individualized fit

Are at risk for skin/soft tissue breakdown and/or deep tissue injury

### DIMENSIONS

Width: 36 in. / 91.5 cm  
Depth: 81.75 in. / 207.5 cm  
Height: 3.5 in. / 9 cm  
Weight: 6.5 lbs / 2.9 kg

### LIMITED WARRANTY

Mattress: 18 months  
Cover: 6 months

### WEIGHT LIMIT

330 lbs / 150 kg



## ROHO PRODIGY Mattress Overlay System

PRODIGY's three independent sections can be adjusted separately to accommodate changing needs. The flexible, interconnected AIR FLOATATION air cells match the body's contour to provide skin/soft tissue and deep tissue injury protection.

The PRODIGY Mattress Overlay System is not dependent on an electrical air pump and thus it produces no sound, heat or vibrations.

The PRODIGY Mattress Overlay has drainage holes in the base, allowing fluid to drain away from the body.

- Adjustable for size and weight change
- Easy to clean, disinfect, and patch
- Provides 3 in / 7.5 cm of immersion
- Polyvinyl chloride (made without DEHP)

---

### IDEAL FOR PEOPLE WHO

Are at risk for skin/soft tissue breakdown

### DIMENSIONS

Width: 36 in. / 91.5 cm  
Depth: 81.75 in. / 207.5 cm  
Height: 3.5 in. / 9 cm  
Weight: 9.5 lbs / 4.3 kg

### LIMITED WARRANTY

Mattress Overlay: 12 months

### WEIGHT LIMIT

300 lbs / 136 kg



# WHEELCHAIR BACK SYSTEMS

---

ROHO AGILITY® Wheelchair Back Systems are designed to fit you and your unique needs. And even better, they fit virtually any wheelchair.

ROHO AGILITY® Standard Series

ROHO AGILITY® CARBON Back Systems





## ROHO AGILITY® Standard Series

No matter where you go, your AGILITY Back will stay in position. Lightweight and durable, the shell's aircraft-grade aluminum and AIR FLOATATION insert provide stability, protection and comfort all in one.

ROHO AGILITY Max Contour Back System

ROHO AGILITY Mid Contour Back System

ROHO AGILITY Minimum Contour Back System

ROHO AGILITY Custom Back System



## ROHO AIR FLOATATION™ Technology

ROHO AGILITY backs are lightweight and designed to conform to the user's body. AGILITY backs integrate ROHO's AIR FLOATATION Technology. The air insert is fully adjustable and can be tailored to your comfort level and postural needs.



## Flip-a-bility

- Adaptable to fit varying body shapes
- Can be flipped to accommodate wider torsos or broader shoulders
- Full range of angle, depth, width and vertical adjustment capabilities are available to address specific positioning needs

---

## AGILITY® Hardware

AGILITY backs are available with two adjustable hardware attachment options and one nonadjustable hardware option. Quick release and fixed hardware can be adjusted the same way once installed.



### QUICK RELEASE

Quick release hardware makes removal for transport or storage a snap, even for those with limited hand dexterity. Simply unlock and lift by the handle.



### FIXED

Fixed hardware is ideal for those who rarely need to remove their backs and want a streamlined mounting option.



### DIRECT MOUNT

Direct mount hardware is exclusively for Permobil Power Wheelchairs\* and is compatible with the AGILITY Aluminum Series.

\*Attaches to compatible Permobil Power Wheelchairs that have third-generation Corpus Seating and a weight limit under 300 lbs.

The AGILITY quick release and fixed hardware are made from Zytel®, a product of DuPont™, which provides an excellent strength-to-weight ratio. Zytel is valued for its high mechanical strength and abrasion resistance, as well as chemical and flame-resistant properties.

The quick release and fixed hardware exhibited no damage and did not move out of position when aggressively subjected to 300 pounds of force exerted for 100,000 cycles. AGILITY sustained over 1,000 times more cycles than its leading competitor.



## ROHO AGILITY Max

Contour Back System

The AGILITY Max provides significant posterior and lateral trunk support for optimal posture and stability.

It is the only deep contour back with independent, adjustable, lateral air pads for better positioning and increased comfort.

### OPTIONS:

- Foam with Air Insert
- Foam with Air Insert and Lumbar Support

---

### DIMENSIONS

Width: 13 in. to 20 in. /  
33 cm to 51 cm  
Depth with Air Insert: 7 in. / 18 cm  
Height: 16 in. to 20 in. /  
40.5 cm to 51 cm  
Weight: 4.25 lbs. to 6.5 lbs. /  
2.0 kg to 3.0 kg

### LIMITED WARRANTY

Back Shell & Hardware: 5 years  
Air Insert: 18 months  
Cover & Foam: 18 months  
Custom Air Insert: 36 months

### WEIGHT LIMIT

300 lbs. / 136 kg



## ROHO AGILITY Mid

Contour Back System

The AGILITY MID provides posterior trunk support and moderate lateral support.

As with all AGILITY Back models, the system is easily installed and adjusted. Height, depth and angle adjustments can be made while you are still in your wheelchair.

### OPTIONS:

- Foam with Air Insert
- Foam with Air Insert and Lumbar Support

---

### DIMENSIONS

Width: 13 in. to 20 in. /  
33 cm to 51 cm  
Depth: 4 in. / 10 cm  
Height: 10 in. to 20 in. /  
25.5 cm to 51 cm  
Weight: 2.5 lbs. to 6 lbs. /  
1.1 kg to 2.8 kg

### LIMITED WARRANTY

Back Shell & Hardware: 5 years  
Air Insert: 36 months  
Cover & Foam: 18 months  
Custom Air Insert: 36 months

### WEIGHT LIMIT

300 lbs. / 136 kg



## ROHO AGILITY Min

Contour Back System

The AGILITY Minimum provides basic postural support in a durable, comfortable package.

While you are in your wheelchair, you can adjust your AGILITY Back height up to 4 in. (10 cm) and your depth up to 1 in. (2.5 cm). You can also get up to 15 degrees of anterior or posterior tilt.

### OPTIONS:

- Foam Only
- Foam with Lumbar Support
- Foam with Air Insert
- Foam with Air Insert and Lumbar Support

---

### DIMENSIONS

Width: 13 in. to 20 in. /  
33 cm to 51 cm  
Depth: Foam: 2.5 in / 6.5 cm  
Foam/Air: 3 in. / 7.5 cm  
Height: 10 in. to 18 in. /  
25.5 cm to 45.5 cm  
Weight: 2.5 lbs. to 5.25 lbs. /  
1.1 kg to 2.3 kg

### LIMITED WARRANTY

Back Shell & Hardware: 5 years  
Air Insert: 18 months  
Cover & Foam: 18 months  
Custom Air Insert: 36 months

### WEIGHT LIMIT

300 lbs. / 136 kg





## AGILITY Laterals

Designed to provide additional trunk support and positioning for individuals. Fits all sizes of AGILITY™ Minimum Contour and AGILITY™ Mid Contour Back Systems.

Available in swing-away and fixed brackets with flush or offset mounts.

- Swing-away brackets come with curved base with foam pad and cover.
- Fixed brackets come with flat base with foam pad and cover.

Order in singles to allow combination of one fixed and one swing-away, which allows individuals to use the swing-away lateral on their transfer side for easier transfers.



## Agility Headrest Adapter Plate

Compatible with OEM headrests with the center bolt spacing of:

- 1/4"- 20 Thread: 1", 7/8", 2" and 3" horizontally 2" vertically
- M6 (1.0) Thread: 1", and 2" horizontally and 2" vertically

The purpose of this product is to allow additional headrests from other DME manufacturers to work with our AGILITY Back.



## ROHO AGILITY® Custom Back System

You're unique – and your ROHO AGILITY Back can be too. Our customization process will select exactly the right sizes and components to fit your body shape and postural support needs.

AGILITY Custom backs fit all shell sizes and are available in variable combinations of DRY FLOATATION® Technology air cell heights to meet your specific needs for comfort, support and posture. Add multiple- or single-valve options for air flow control and additional positioning support.

- Customize number of valves and compartments
- Customize cell heights:
  - 1.25 in. / 3 cm
  - 2.25 in. / 5.5 cm
  - 3.25 in. / 8.5 cm
  - 4.25 in. / 10.5 cm
- Eliminate cells and sections

**LIMITED WARRANTY**  
 Back Shell & Hardware: 5 years  
 Air Insert: 36 months  
 Cover & Foam: 18 months

**MEDICARE CODES**  
 E2617

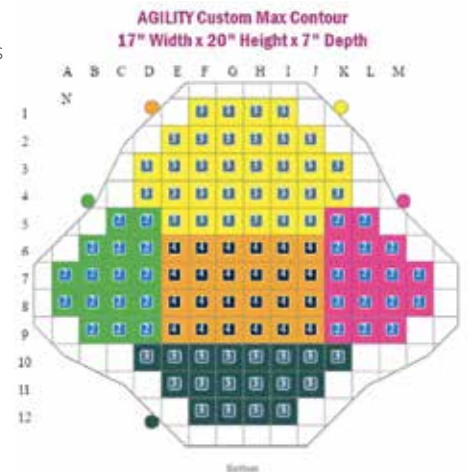



## ROHO AGILITY CARBON Back System

The lightweight carbon fiber construction of the AGILITY CARBON Series combines high-strength performance with a leading-edge design.

It's precision crafted, and it really does look as good as it feels. It is made to move you. The AGILITY CARBON's single, integrated clamps are clean and simple – while remaining smaller, lighter and stronger than most other fixed backs. Every AGILITY CARBON series marries the stability of carbon with ROHO's exclusive AIR FLOATATION Technology.

- Flippable
- Adjustable AIR FLOATATION insert
- Strong yet lightweight construction
- Durable

## The innovative carbon fiber shell is compression molded to provide strength without bulk.

The shell can be flipped to accommodate each individual's body type, all while maintaining a higher degree of comfort. With just a single clamp on either side, the AGILITY CARBON's integrated hardware maintains a clean appearance while remaining smaller, lighter and stronger than most fixed back hardware.



### OPTIONS:

- Foam with Air Insert
- The adjustment disks lock the back in place but still allow for up to 15 degrees of forward and rearward adjustment



### ROHO AGILITY CARBON Min Contour Back System

#### DIMENSIONS

Width: 13.75 in. to 18.75 in. /  
34.9 cm to 47.6 cm  
Depth: 3 in. / 7.5 cm  
Height: 10 in. to 16 in. /  
25.5 cm to 40.5 cm  
Weight: 1.75 lbs. / .815 kg  
Based on 14 in. x 10 in. /  
35.5 cm x 25.5 cm (weight ranges  
include hardware)

#### LIMITED WARRANTY

Back Shell & Hardware: 36 months  
Foam & Cover Components: 18 months  
Urethane Inserts: 18 months

#### WEIGHT LIMIT

265 lbs. / 120.2 kg



### ROHO AGILITY CARBON Mid Contour Back System

#### DIMENSIONS

Width: 13.75 in. to 18.75 in. /  
34.9 cm to 47.6 cm  
Depth: 4 in. / 10 cm  
Height: 10 in. to 16 in. /  
25.5 cm to 40.5 cm  
Weight: 1.75 lbs. / 0.815 kg  
Based on 14 in. x 10 in.  
35.5 cm x 25.5 cm (weight ranges  
include hardware)

#### LIMITED WARRANTY

Back Shell & Hardware: 36 months  
Foam & Cover Components: 18 months  
Urethane Inserts: 18 months

#### WEIGHT LIMIT

265 lbs. / 120.2 kg

# Measurement Instructions

Read the measurements in this brochure and in the product documentation at permobilus.com.



## CUSHION HEIGHT

The height of a normal inflated cushion without load and without possible edging or seat shell.

These measurements may also be found in the product descriptions and on product labels.



## CUSHION WIDTH

Cushion width measured from edge to edge without load.

These measurements may also be found in the product descriptions and on product labels.



## CUSHION DEPTH

Cushion depth measured from edge to edge without load.

These measurements may also be found in the product descriptions and on product labels.



## SEAT WIDTH

The appropriate seat width for using the cushion.

See also "appropriate width" in the list of prices.



## SEAT DEPTH

The appropriate seat depth for using the cushion.

See also "appropriate depth" in the list of prices.

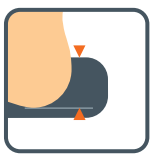

## EFFECTIVE HEIGHT OF DRY FLOATATION® / AIR FLOATATION™

Spacing between the lower portion of the body and the top of the seat cushion or mattress. The effective height of DRY FLOATATION® (height for AIR FLOATATION™ products with AIR FLOATATION™ technology) makes assumptions regarding the depth to which the body sinks into the cushion. The deeper, the greater the contact surface and the lower the pressure per cm<sup>2</sup> of skin.

### CUSHION WIDTH AND DEPTH

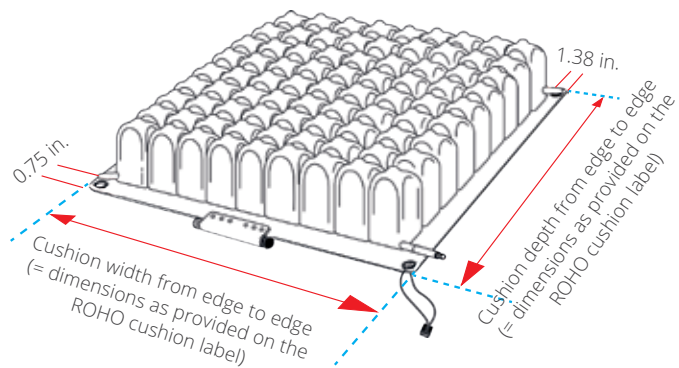

### SEAT WIDTH AND DEPTH

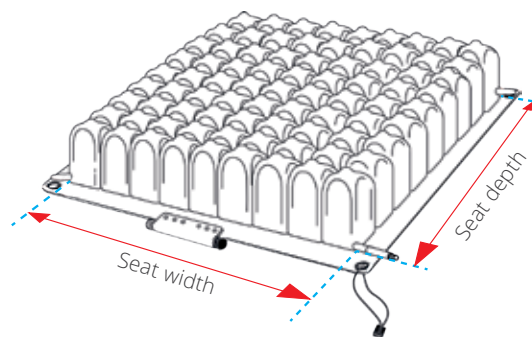

NOTE: Cushions with no weight limit must be sized correctly to the individual.

# Select the correct size ROHO Cushion for your wheelchair:

**Step 1** Measure the wheelchair seat width and depth.  
 Note: Wheelchair manufacturers' published seat dimensions may vary.

**Step 2** Use your wheelchair seat dimensions and the below table to help you determine the number of cells in cushion width and in depth.

ROHO® NEOPRENE CUSHION SIZING CHART

Fits wheelchair size (in. / cm)	Number of cells
10 / 22 to 26.5	5
11 to 12 / 26.5 to 31	6
13 / 31 to 35	7
14 to 15 / 35 to 39.5	8
16 to 17 / 39.5 to 44	9
18 to 19 / 44 to 48.5	10
20 to 21 / 48.5 to 52.5	11
22 / 52.5 to 57	12
23 to 24 / 57 to 61	13
25 / 61 to 65.5	14
26 to 27 / 65.5 to 70	15

Note: Availability of cushion sizes varies by model.

SINGLE COMPARTMENT CUSHIONS

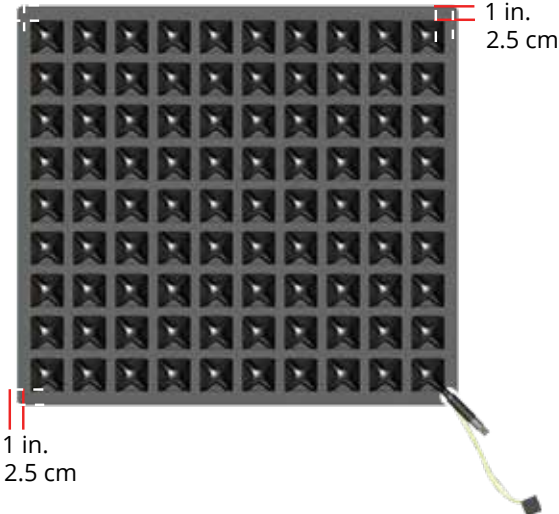

SELECT SERIES CUSHIONS

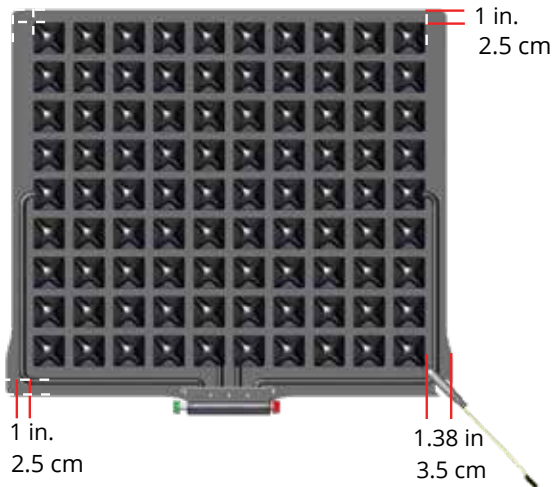

# Cushion Sizing Charts

## Hybrid Elite SR™ Cushion

Model	Fits wheelchair (in.)	Fits wheelchair (cm)
1RHE1414C-SR	14" x 14"	35.5 x 35.5
1RHE1415C-SR	14" x 15"	35.5 x 38
1RHE1416C-SR	14" x 16"	38 x 40.5
1RHE1515C-SR	15" x 15"	38 x 38
1RHE1516C-SR	15" x 16"	38 x 40.5
1RHE1517C-SR	15" x 17"	38 x 43
1RHE1615C-SR	16" x 15"	40.5 x 38
1RHE1616C-SR	16" x 16"	40.5 x 40.5
1RHE1617C-SR	16" x 17"	40.5 x 43
1RHE1618C-SR	16" x 18"	40.5 x 45.5
1RHE1620C-SR	16" x 20"	40.5 x 51
1RHE1716C-SR	17" x 16"	43 x 40.5
1RHE1717C-SR	17" x 17"	43 x 43
1RHE1718C-SR	17" x 18"	43 x 45.5
1RHE1816C-SR	18" x 16"	45.5 x 40.5
1RHE1817C-SR	18" x 17"	45.5 x 43
1RHE1818C-SR	18" x 18"	45.5 x 45.5
1RHE1820C-SR	18" x 20"	45.5 x 51
1RHE2017C-SR	20" x 17"	51 x 43
1RHE2018C-SR	20" x 18"	51 x 45.5
1RHE2020C-SR	20" x 20"	51 x 51
1RHE2218C-SR	22" x 18"	56 x 45.5
1RHE2220C-SR	22" x 20"	56 x 51
1RHE2222C-SR	22" x 22"	56 x 56
1RHE2418C-SR	24" x 18"	61 x 45.5
1RHE2420C-SR	24" x 20"	61 x 51

## AirLITE® Cushion

Model	Fits wheelchair (in.)	Fits wheelchair (cm)
AL1313HD	13" x 13"	33 x 33
AL1315HD	13" x 15"	33 x 38
AL1414HD	14" x 14"	36 x 36
AL1416HD	14" x 16"	36 x 41
AL1515HD	15" x 15"	38 x 38
AL1517HD	15" x 17"	38 x 43
AL1616HD	16" x 16"	41 x 41
AL1618HD	16" x 18"	41 x 46
AL1717HD	17" x 17"	43 x 43
AL1718HD	17" x 18"	43 x 46
AL1720HD	17" x 20"	43 x 51
AL1816HD	18" x 16"	46 x 41
AL1818HD	18" x 18"	46 x 46
AL1820HD	18" x 20"	46 x 51
AL1917HD	19" x 17"	48 x 43
AL1919HD	19" x 19"	48 x 48
AL2017HD	20" x 17"	51 x 43
AL2018HD	20" x 18"	51 x 46

## Hybrid Elite® Dual Valve Cushion

Model	Fits wheelchair (in.)	Fits wheelchair (cm)
2RHE1414C	14" x 14"	36 x 36
2RHE1415C	14" x 15"	36 x 38
2RHE1416C	14" x 16"	36 x 41
2RHE1515C	15" x 15"	38 x 38
2RHE1516C	15" x 16"	38 x 41
2RHE1517C	15" x 17"	38 x 43
2RHE1615C	16" x 15"	41 x 38
2RHE1616C	16" x 16"	41 x 41
2RHE1617C	16" x 17"	41 x 43
2RHE1618C	16" x 18"	41 x 46
2RHE1620C	16" x 20"	41 x 51
2RHE1716C	17" x 16"	43 x 41
2RHE1717C	17" x 17"	43 x 43
2RHE1718C	17" x 18"	43 x 46
2RHE1816C	18" x 16"	46 x 41
2RHE1817C	18" x 17"	46 x 43
2RHE1818C	18" x 18"	46 x 46
2RHE1820C	18" x 20"	46 x 51
2RHE2017C	20" x 17"	51 x 43
2RHE2018C	20" x 18"	51 x 46
2RHE2020C	20" x 20"	51 x 51

## nexus SPIRIT® Cushion

Model	Fits wheelchair (in.)	Fits wheelchair (cm)
NS1414C	14" x 14"	36 x 36
NS1416C	14" x 16"	36 x 41
NS1515C	15" x 15"	38 x 38
NS1616C	16" x 16"	41 x 41
NS1618C	16" x 18"	41 x 46
NS1717C	17" x 17"	43 x 43
NS1816C	18" x 16"	46 x 41
NS1818C	18" x 18"	46 x 46
NS2018C	20" x 18"	51 x 46

## HARMONY® Cushion

Model	Fits wheelchair (in.)	Fits wheelchair (cm)
H1416C	14" x 16"	36 x 41
H1616C	16" x 16"	41 x 41
H1618C	16" x 18"	41 x 46
H1716C	17" x 16"	43 x 41
H1718C	17" x 18"	43 x 46
H1816C	18" x 16"	46 x 41
H1818C	18" x 18"	46 x 46
H2018C	20" x 18"	51 x 46

Note: Sizes listed represent wheelchair size. Actual cushion size is approximately 1.5 in. deeper to allow for placement between back support canes.

# ROHO® AGILITY® Standard Series Sizing Charts

For insert choices remove the # from the model number and replace with:

- F for Foam Only
- FL for Foam and Lumbar Pad
- A for Air Only
- AL for Air with Lumbar Pad

For hardware choices remove the X from the model number and replace with:

- 1 for Quick Release hardware
- 2 for Fixed hardware

Note: Fixed hardware is not available in heights taller than 16"

## MINIMUM CONTOUR (AG2)

ITEM	Fits wheelchair (in.)	Fits wheelchair (cm)
AG2-1410#-X	13" to 14"	33 to 35.5
AG2-1413#-X	13" to 14"	33 to 35.5
AG2-1416#-X	13" to 14"	33 to 35.5
AG2-1418#-X	13" to 14"	33 to 35.5
AG2-1510#-X	14" to 15"	35.5 to 38
AG2-1513#-X	14" to 15"	35.5 to 38
AG2-1516#-X	14" to 15"	35.5 to 38
AG2-1518#-X	14" to 15"	35.5 to 38
AG2-1610#-X	15" to 16"	38 to 40.5
AG2-1613#-X	15" to 16"	38 to 40.5
AG2-1616#-X	15" to 16"	38 to 40.5
AG2-1618#-X	15" to 16"	38 to 40.5
AG2-1710#-X	16" to 17"	40.5 to 43
AG2-1713#-X	16" to 17"	40.5 to 43
AG2-1716#-X	16" to 17"	40.5 to 43
AG2-1718#-X	16" to 17"	40.5 to 43
AG2-1810#-X	17" to 18"	43 to 45.5
AG2-1813#-X	17" to 18"	43 to 45.5
AG2-1816#-X	17" to 18"	43 to 45.5
AG2-1818#-X	17" to 18"	43 to 45.5
AG2-1910#-X	18" to 19"	45.5 to 48.5
AG2-1913#-X	18" to 19"	45.5 to 48.5
AG2-1916#-X	18" to 19"	45.5 to 48.5
AG2-1918#-X	18" to 19"	45.5 to 48.5
AG2-2010#-X	19" to 20"	48.5 to 51
AG2-2013#-X	19" to 20"	48.5 to 51
AG2-2016#-X	19" to 20"	48.5 to 51
AG2-2018#-X	19" to 20"	48.5 to 51

## MID CONTOUR (AG3)

Available only with Air Only (A) and Air with Lumbar Pad (AL) inserts.

ITEM	Fits wheelchair (in.)	Fits wheelchair (cm)
AG3-1410#-X	13" to 14"	33 to 35.5
AG3-1413#-X	13" to 14"	33 to 35.5
AG3-1416#-X	13" to 14"	33 to 35.5
AG3-1418#-X	13" to 14"	33 to 35.5
AG3-1510#-X	14" to 15"	35.5 to 38
AG3-1513#-X	14" to 15"	35.5 to 38
AG3-1516#-X	14" to 15"	35.5 to 38
AG3-1518#-X	14" to 15"	35.5 to 38
AG3-1610#-X	15" to 16"	38 to 40.5
AG3-1613#-X	15" to 16"	38 to 40.5
AG3-1616#-X	15" to 16"	38 to 40.5
AG3-1618#-X	15" to 16"	38 to 40.5
AG3-1710#-X	16" to 17"	40.5 to 43
AG3-1713#-X	16" to 17"	40.5 to 43
AG3-1716#-X	16" to 17"	40.5 to 43
AG3-1718#-X	16" to 17"	40.5 to 43
AG3-1810#-X	17" to 18"	43 to 45.5
AG3-1813#-X	17" to 18"	43 to 45.5
AG3-1816#-X	17" to 18"	43 to 45.5
AG3-1818#-X	17" to 18"	43 to 45.5
AG3-1910#-X	18" to 19"	45.5 to 48.5
AG3-1913#-X	18" to 19"	45.5 to 48.5
AG3-1916#-X	18" to 19"	45.5 to 48.5
AG3-1918#-X	18" to 19"	45.5 to 48.5
AG3-2010#-X	19" to 20"	48.5 to 51
AG3-2013#-X	19" to 20"	48.5 to 51
AG3-2016#-X	19" to 20"	48.5 to 51
AG3-2018#-X	19" to 20"	48.5 to 51
AG3-2020#-X	19" to 20"	48.5 to 51

# ROHO AGILITY CARBON Back System Sizing Charts

## MAX CONTOUR (AG6)

Available only with Air Only (A) and  
Air with Lumbar Pad (AL) inserts.

ITEM	Fits wheelchair (in.)	Fits wheelchair (cm)
AG6-1416#-X	13" to 14"	33 to 35.5
AG6-1418#-X	13" to 14"	33 to 35.5
AG6-1420#-X	13" to 14"	33 to 35.5
AG6-1516#-X	14" to 15"	35.5 to 38
AG6-1518#-X	14" to 15"	35.5 to 38
AG6-1520#-X	14" to 15"	35.5 to 38
AG6-1616#-X	15" to 16"	38 to 40.5
AG6-1618#-X	15" to 16"	38 to 40.5
AG6-1620#-X	15" to 16"	38 to 40.5
AG6-1716#-X	16" to 17"	40.5 to 43
AG6-1718#-X	16" to 17"	40.5 to 43
AG6-1720#-X	16" to 17"	40.5 to 43
AG6-1816#-X	17" to 18"	43 to 45.5
AG6-1818#-X	17" to 18"	43 to 45.5
AG6-1820#-X	17" to 18"	43 to 45.5
AG6-1916#-X	18" to 19"	45.5 to 48.5
AG6-1918#-X	18" to 19"	45.5 to 48.5
AG6-1920#-X	18" to 19"	45.5 to 48.5
AG6-2016#-X	19" to 20"	48.5 to 51
AG6-2018#-X	19" to 20"	48.5 to 51
AG6-2020#-X	19" to 20"	48.5 to 51

## AGILITY CARBON MINIMUM CONTOUR

ITEM	Fits wheelchair width (in.)	Fits wheelchair width (cm)
AG2-1410A-2CB	14"	35.5 cm
AG2-1413A-2CB	14"	35.5 cm
AG2-1416A-2CB	14"	35.5 cm
AG2-1510A-2CB	15"	38 cm
AG2-1513A-2CB	15"	38 cm
AG2-1516A-2CB	15"	38 cm
AG2-1610A-2CB	16"	40.5 cm
AG2-1613A-2CB	16"	40.5 cm
AG2-1616A-2CB	16"	40.5 cm
AG2-1710A-2CB	17"	43 cm
AG2-1713A-2CB	17"	43 cm
AG2-1716A-2CB	17"	43 cm
AG2-1810A-2CB	18"	45.5 cm
AG2-1813A-2CB	18"	45.5 cm
AG2-1816A-2CB	18"	45.5 cm

## AGILITY CARBON MID CONTOUR

ITEM	Fits wheelchair width (in.)	Fits wheelchair width (cm)
AG3-1410A-2CB	14"	35.5 cm
AG3-1413A-2CB	14"	35.5 cm
AG3-1416A-2CB	14"	35.5 cm
AG3-1510A-2CB	15"	38 cm
AG3-1513A-2CB	15"	38 cm
AG3-1516A-2CB	15"	38 cm
AG3-1610A-2CB	16"	40.5 cm
AG3-1613A-2CB	16"	40.5 cm
AG3-1616A-2CB	16"	40.5 cm
AG3-1710A-2CB	17"	43 cm
AG3-1713A-2CB	17"	43 cm
AG3-1716A-2CB	17"	43 cm
AG3-1810A-2CB	18"	45.5 cm
AG3-1813A-2CB	18"	45.5 cm
AG3-1816A-2CB	18"	45.5 cm

Note: AGILITY CARBON Back Systems are available only with the Air Only insert.



## Product Use and Maintenance

ROHO products are very user friendly and can be easily used and maintained.

A hand pump and operation manual are included with most ROHO products. The operation manual includes setup, care and cleaning instructions, as well as useful information regarding customer care and the product warranty.

## Cleaning and Disinfecting

Cleaning and disinfecting are separate processes. Cleaning must precede disinfection.

Before use by a different individual, clean, disinfect and check the product for proper functioning.

For cleaning and disinfecting covers, foam bases or backrests, please see the operation manual for specific product instructions.

**To Clean the Cushion:** Remove the cover, close valve(s) and place in a large sink. Hand-wash using mild liquid hand soap, hand dish washing liquid, laundry detergent or a multipurpose detergent. (Follow the product label instructions.) Gently scrub all cushion surfaces using a soft plastic bristle brush, a sponge or a cloth. Rinse with clean water. Air dry. DO NOT expose to direct sunlight.

**To Disinfect the Cushion:** Repeat cleaning instructions, using 1 part household liquid bleach per 9 parts water. Keep the product wet with the bleach solution for 10 minutes. Rinse thoroughly with clean water. Air dry.

Note: Most germicidal disinfectants are safe if used following the disinfectant manufacturer's dilution directions.

Detailed information on cleaning and disinfecting for all ROHO products is available in the product operation manuals.

## Disposal and Recycling

**Disposal:** The components of the products in this catalog are associated with no known environmental hazards when properly used and when disposed of in accordance with all local/regional regulations. Incineration must be performed by a qualified, licensed waste management facility.

**Recycling:** Contact a local recycling agency to determine recycling options for the product. For more recycling information, contact Permobil.

## Returns

All returns require prior authorization from Permobil Australia and may be subject to a restocking fee and freight charge. Before returning your product, please contact our Customer Service for an RGA number. Call 1300 845 483 or +61 2 8838 3100.

## Warranty Information

If you have questions regarding your ROHO product warranty, please contact our Customer Service on 1300 845 483.

Be advised that a charge will be assessed for any service provided for a product that does not qualify under the product's warranty.

Note: All seat cushions, except the ADAPTOR PAD include an inflation pump and repair kit. All ROHO products have operating instructions.

Note: All ROHO cushions and back systems mentioned in this catalog come with a cover except for the following: Shower/Commode Cushion, Toilet Seat Cushion, ADAPTOR® PAD, HEAL PAD® Cushion, and Lumbar Support.

## Quality Management

ROHO, Inc., a division of Permobil, takes quality control much further than the FDA model, with its quality management system being certified to two ISO standards for over 10 years—ROHO, Inc.'s Quality Management System is certified to ISO 13485:2016.

## EC STATEMENT

ROHO® medical products meet the standards and requirements mentioned below, which are controlled by independent institutions:

1. EN-ISO 10993-10 (1999-11) Irritation and sensitization tests (slow type).
2. EN 1021-1 and EN 1021-2 Assessment of ignitability for wheelchair cushions and backs.

ROHO, Inc.'s Quality Management System is currently certified to be in conformity with ISO 13485:2016.

All current ROHO medical products fall under Risk Class 1 Medical Devices.

Registered Trademarks

©2018 Permobil

Permobil has a policy of continual product improvement and reserves the right to amend this document. The current version of this document is available at [permobilus.com](http://permobilus.com).

The following are trademarks and registered trademarks of Permobil ROHO Seating and Positioning: ADAPTOR®, AGILITY®, AGILITY CARBON™, AIR FLOATATION™, AirLITE®, CONTOUR SELECT®, DRY FLOATATION®, Yellow Rope®, ENHANCER®, HEAL PAD®, HIGH PROFILE®, Hybrid Elite®, Hybrid Elite SR™, ISOFLO Memory Control®, LTV®, LOW PROFILE®, MID PROFILE™, MINI-MAX®, MOSAIC®, nexus SPIRIT®, QUADTRO SELECT®, ROHO®, Shape Fitting Technology®, Sensor Ready™ and Smart Check®.

Therafin® is a registered trademark of the Therafin Corporation. Ultra Leather™ is a registered trademark of Ultra Fabrics, Inc. Zytel® is a registered trademark of DuPont™.

ORIGINAL ROHO PRODUCT: Watch for the ROHO logo, yellow rope and unique black ROHO air cells under the cover. If you see these features, you can be sure that you have an original ROHO product.



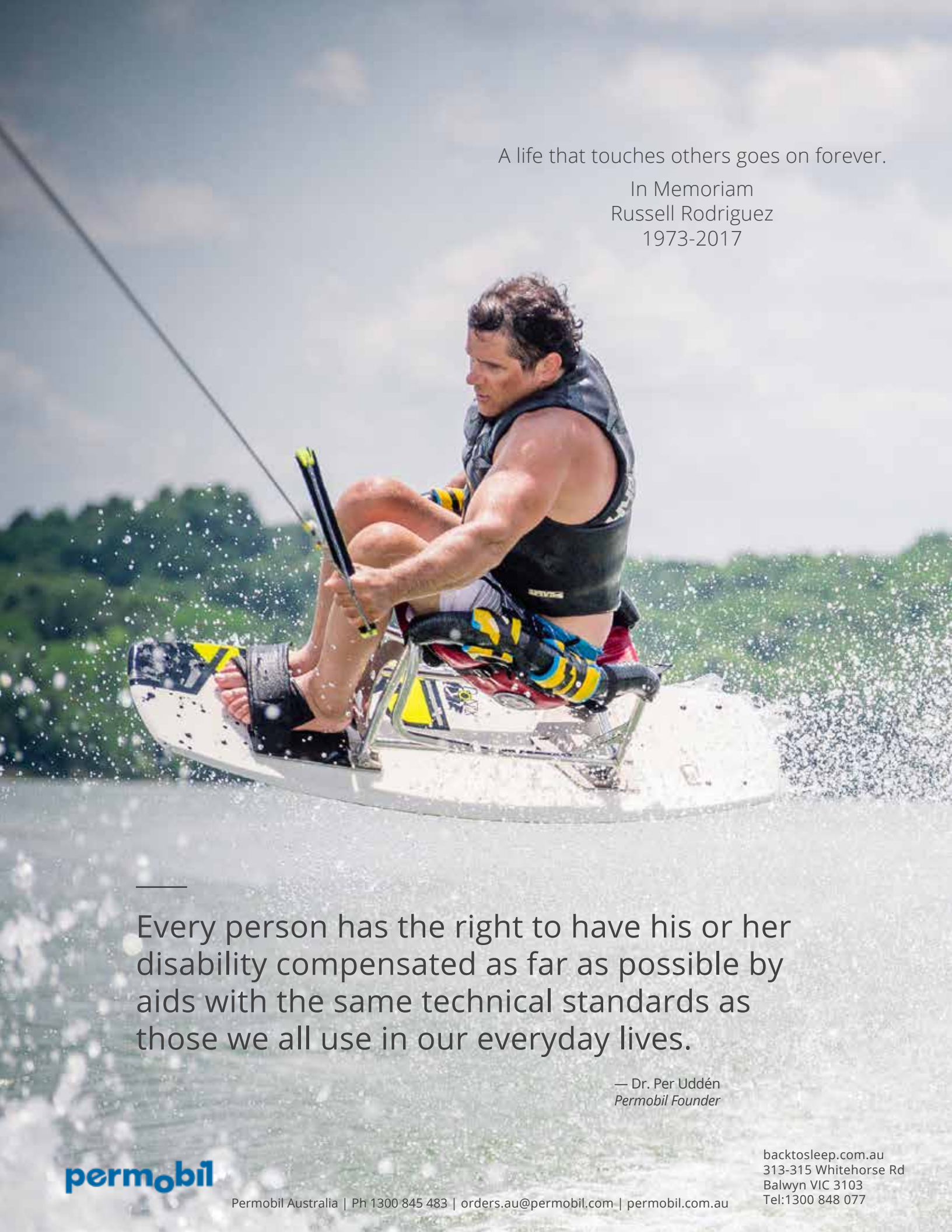

A life that touches others goes on forever.

In Memoriam  
Russell Rodriguez  
1973-2017

---

Every person has the right to have his or her disability compensated as far as possible by aids with the same technical standards as those we all use in our everyday lives.

— Dr. Per Uddén  
*Permobil Founder*

**permobil**

Permobil Australia | Ph 1300 845 483 | [orders.au@permobil.com](mailto:orders.au@permobil.com) | [permobil.com.au](http://permobil.com.au)

[backtosleep.com.au](http://backtosleep.com.au)  
313-315 Whitehorse Rd  
Balwyn VIC 3103  
Tel: 1300 848 077